

# CATALOGUE 2024

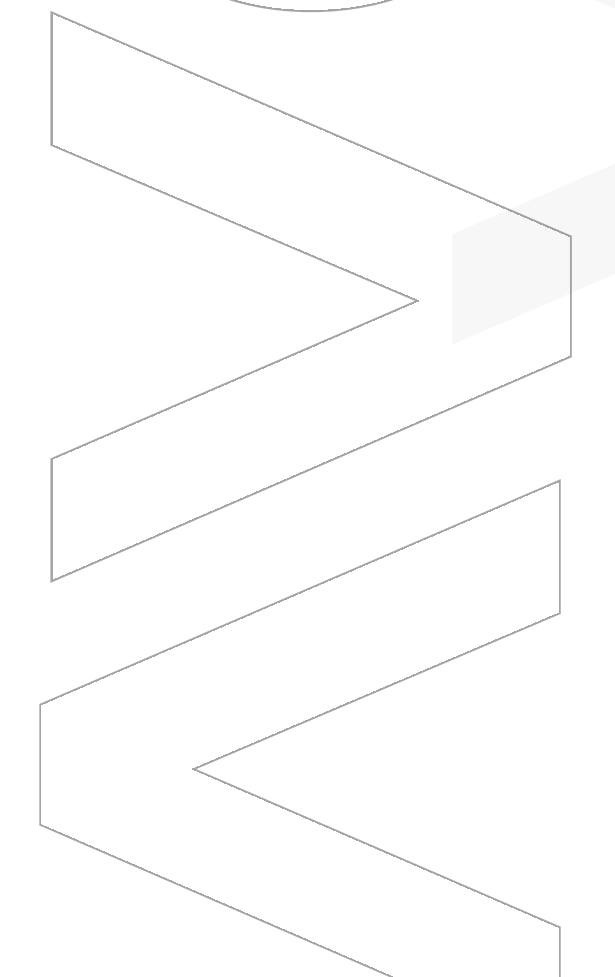
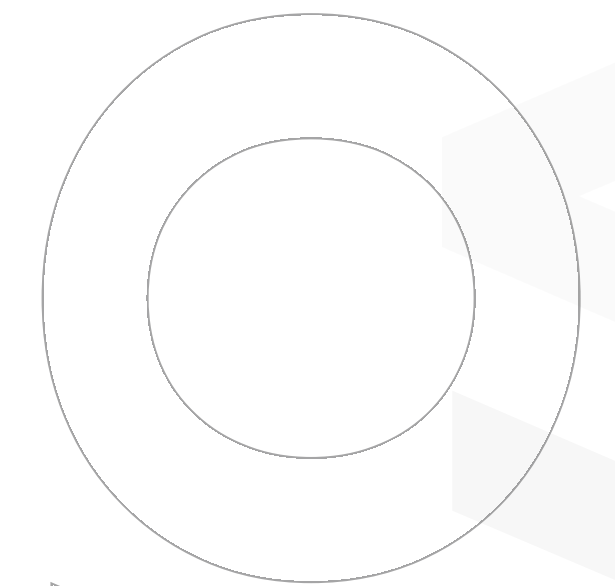

# ABOUT US

IUOVA DESIGN is an Industrial Product Design company established in 2016 by Mr. Vatsal Gudhaka with the sole aim to cater to Companies and Startups to help them create a high-quality market selling product from a concept idea.

We at luova Design focus on bridging the gap between an ideas to a final market ready product. A brilliant idea in itself is not successful, it has to be executed well in physical form as a brilliant product as well. That is where we come into picture.

Our studio houses state of the art facility with proficient designers and engineers who have immense experience in creating amazing products for the clients. At luova, we not only develop products but also do market analysis, feasibility analysis, material analysis and many more crucial processes which help provide best design solutions for our clients.

Our aim is to create world class products in every aspect from aesthetics to performance and market success. We strive to achieve excellence in every aspect.

**Vatsal Gudhaka**

CEO, luova Design





# OUR TEAM



Vatsal Gudhaka



Ashish Raven



Sumedh Ayachit



Anirudha Masurkar



Rigved Patil



Prabhakar Nachare



Roshan Payar



Mandar Ambelkar



Priyanka Dhandore



# OFFICE PREMISES





# MILESTONES

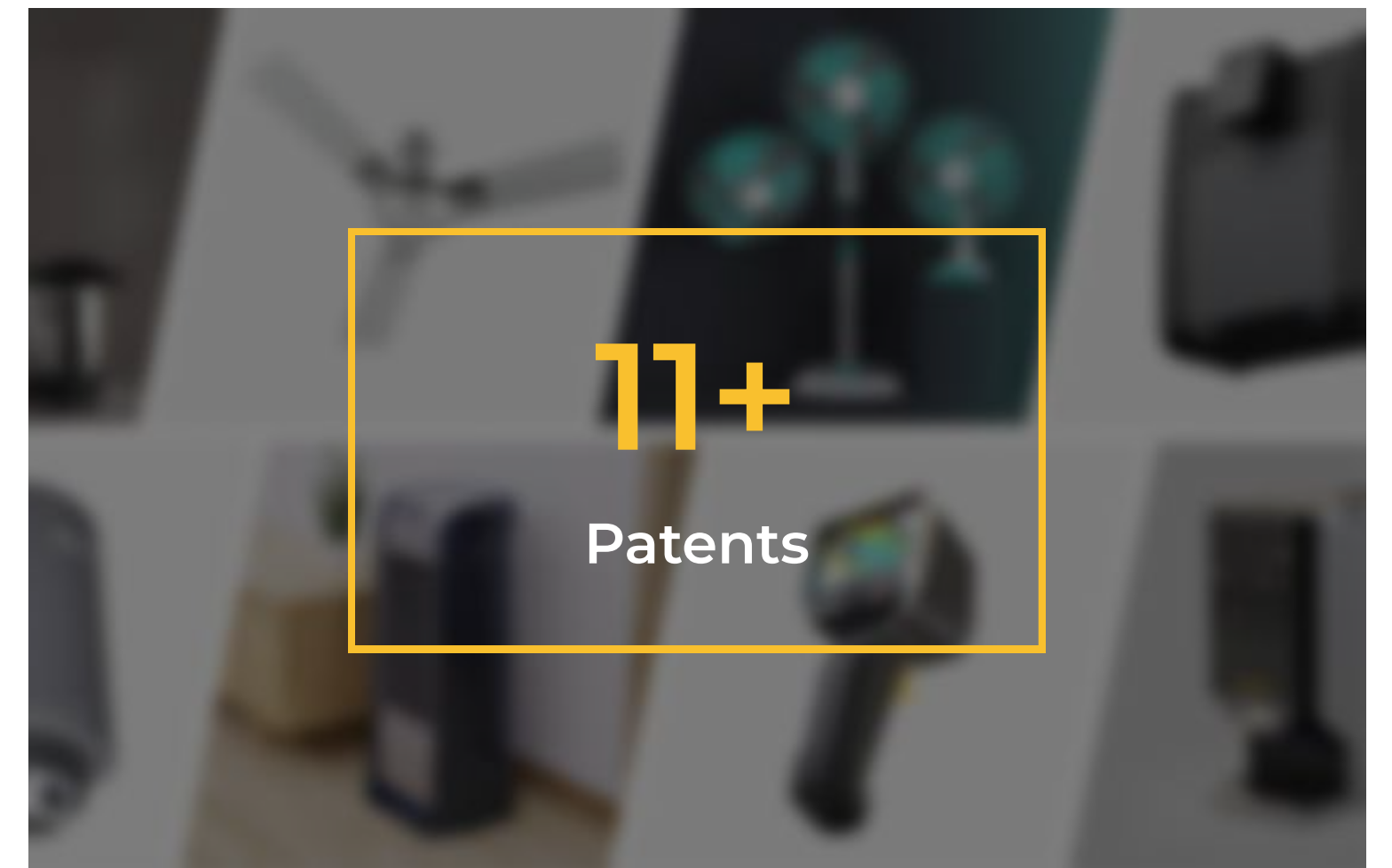
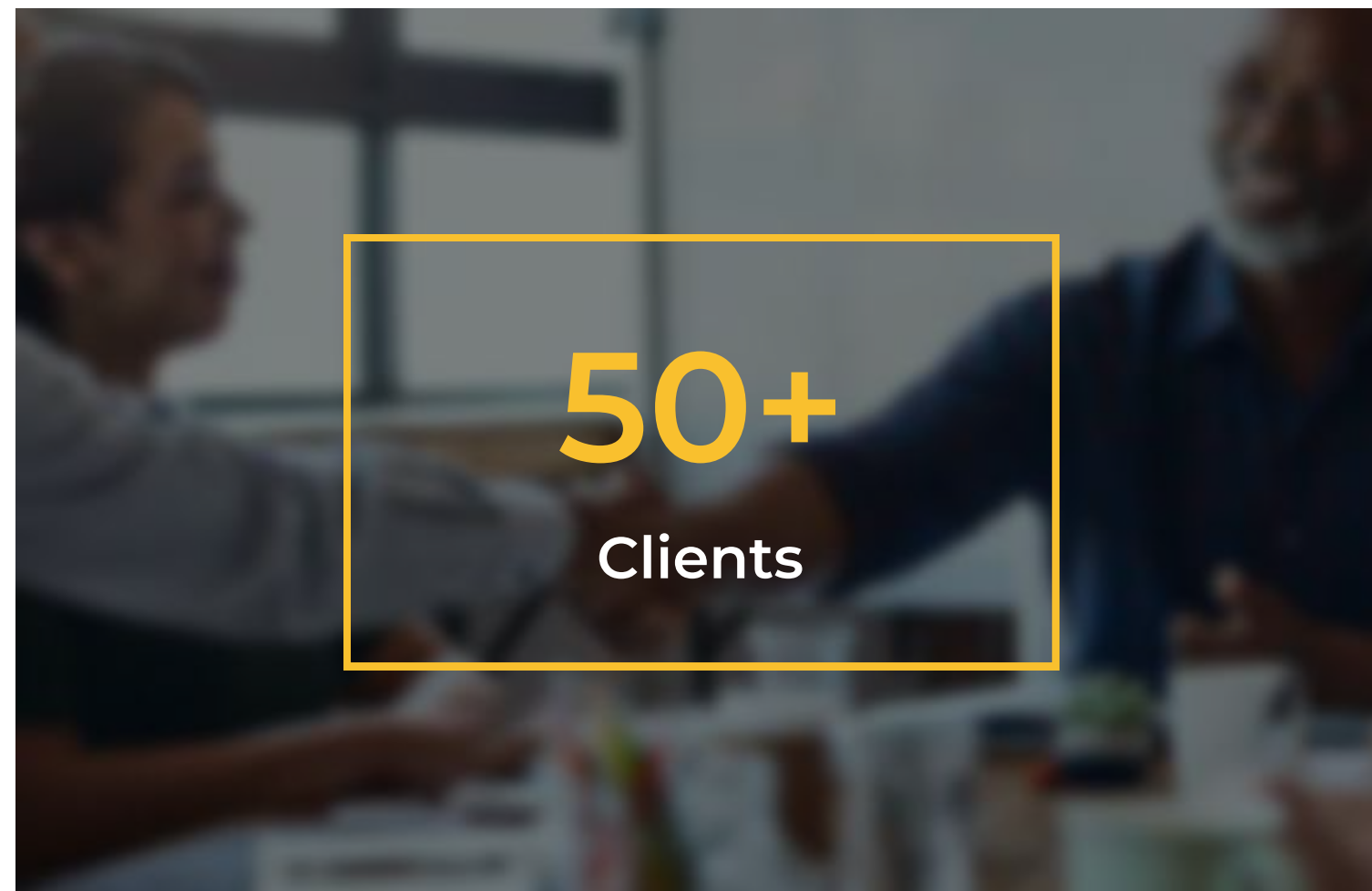
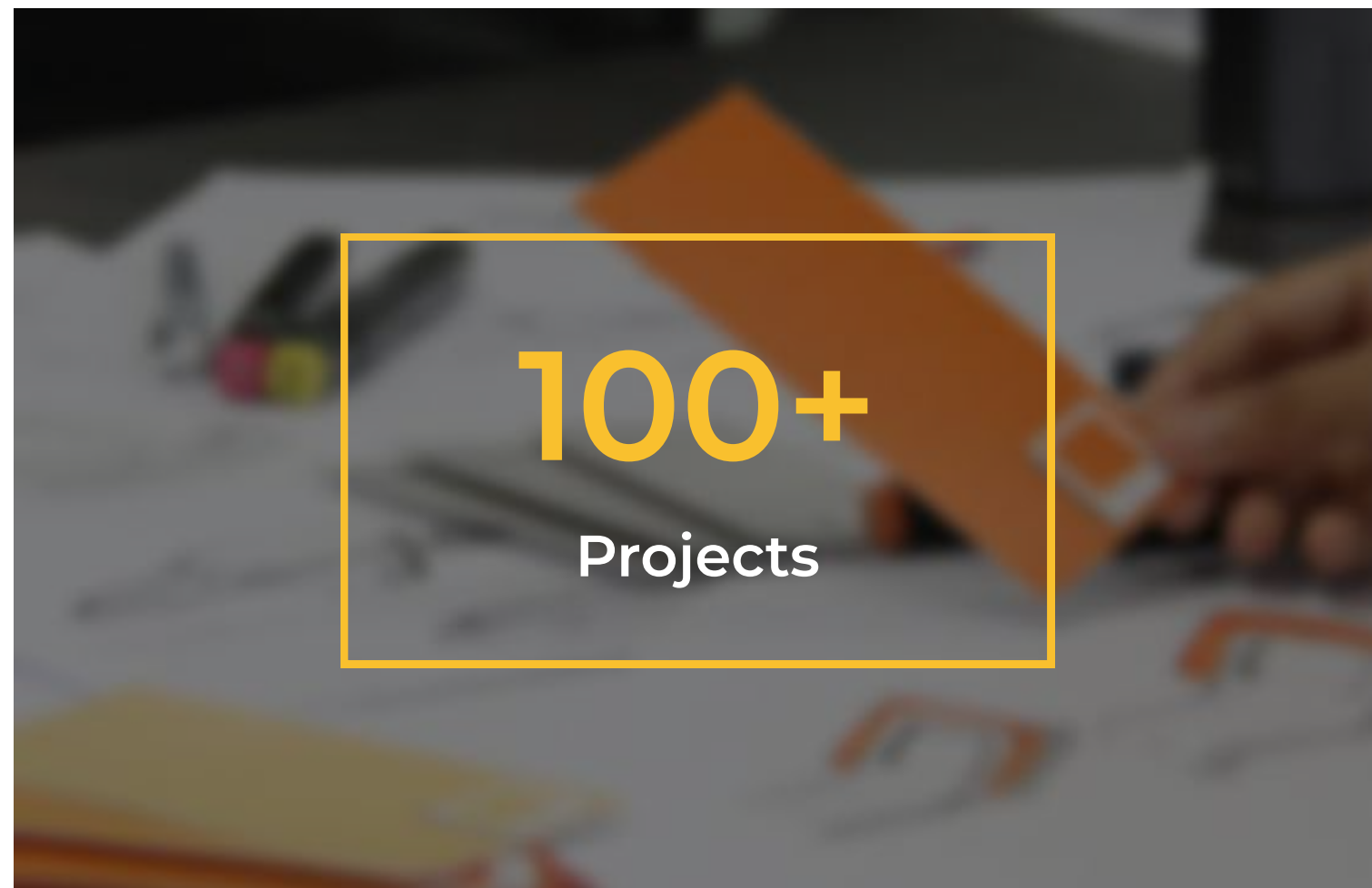



# OUR SERVICES



01

Industrial Product Design



02

Engineering Services

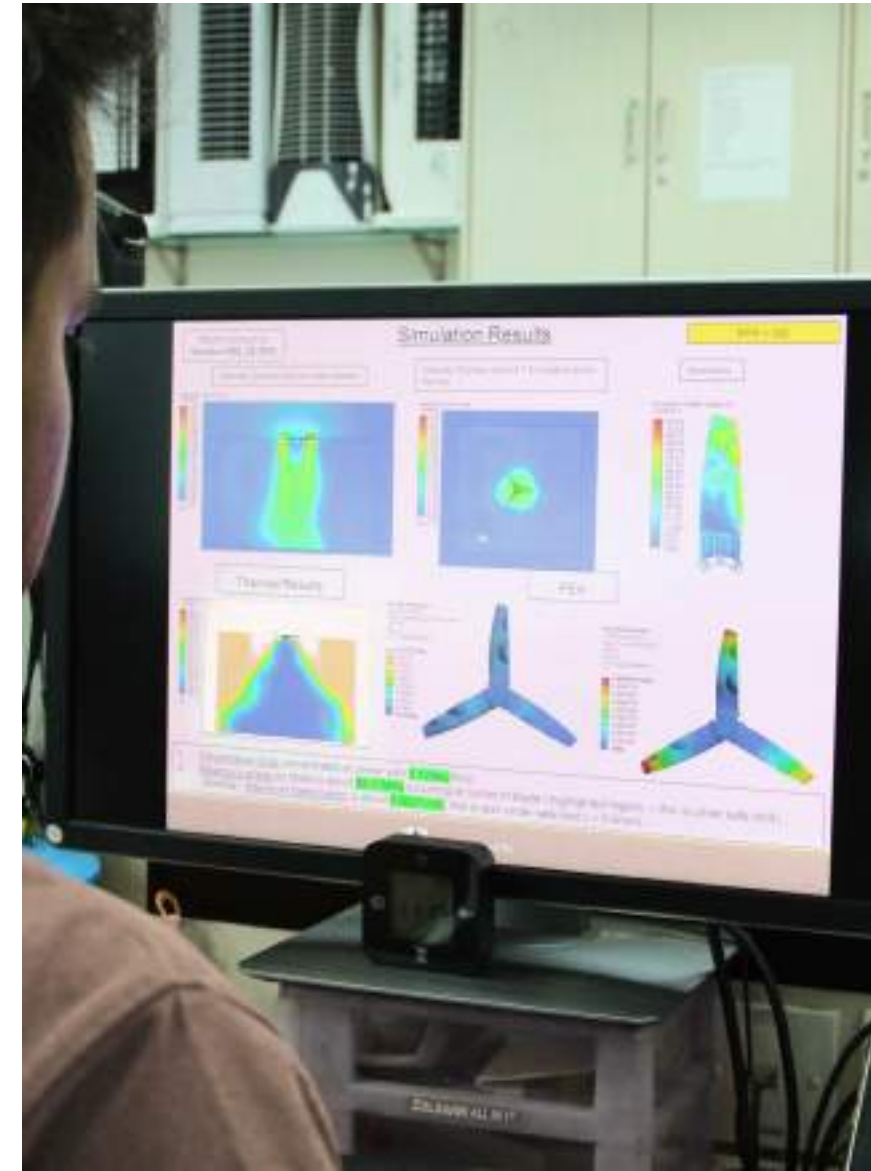

03

Product Analysis Services



04

Prototyping



05

Product Manufacturing



# OUR PROCESS



01

Concept Design and Development

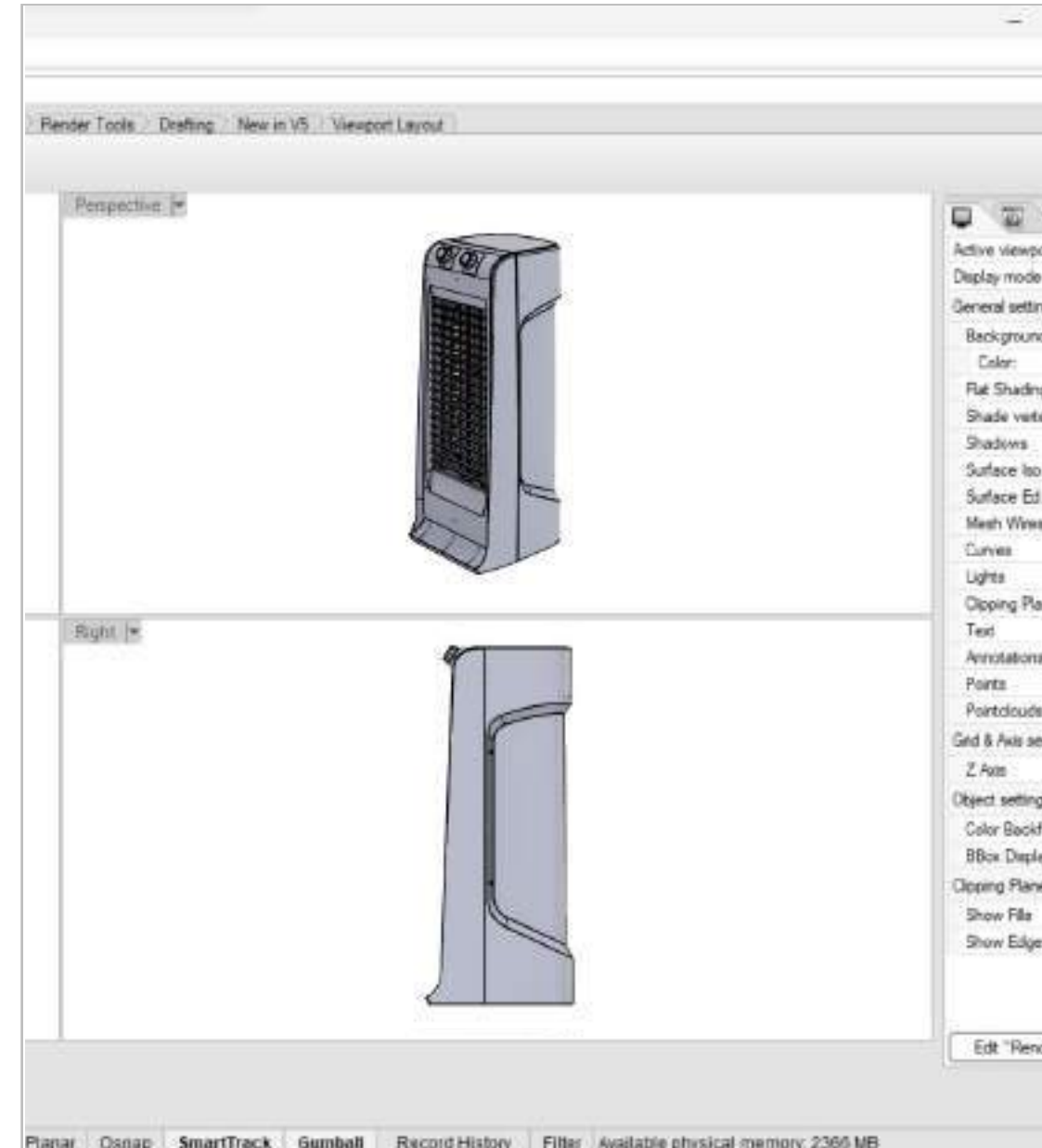

02

3D Modelling

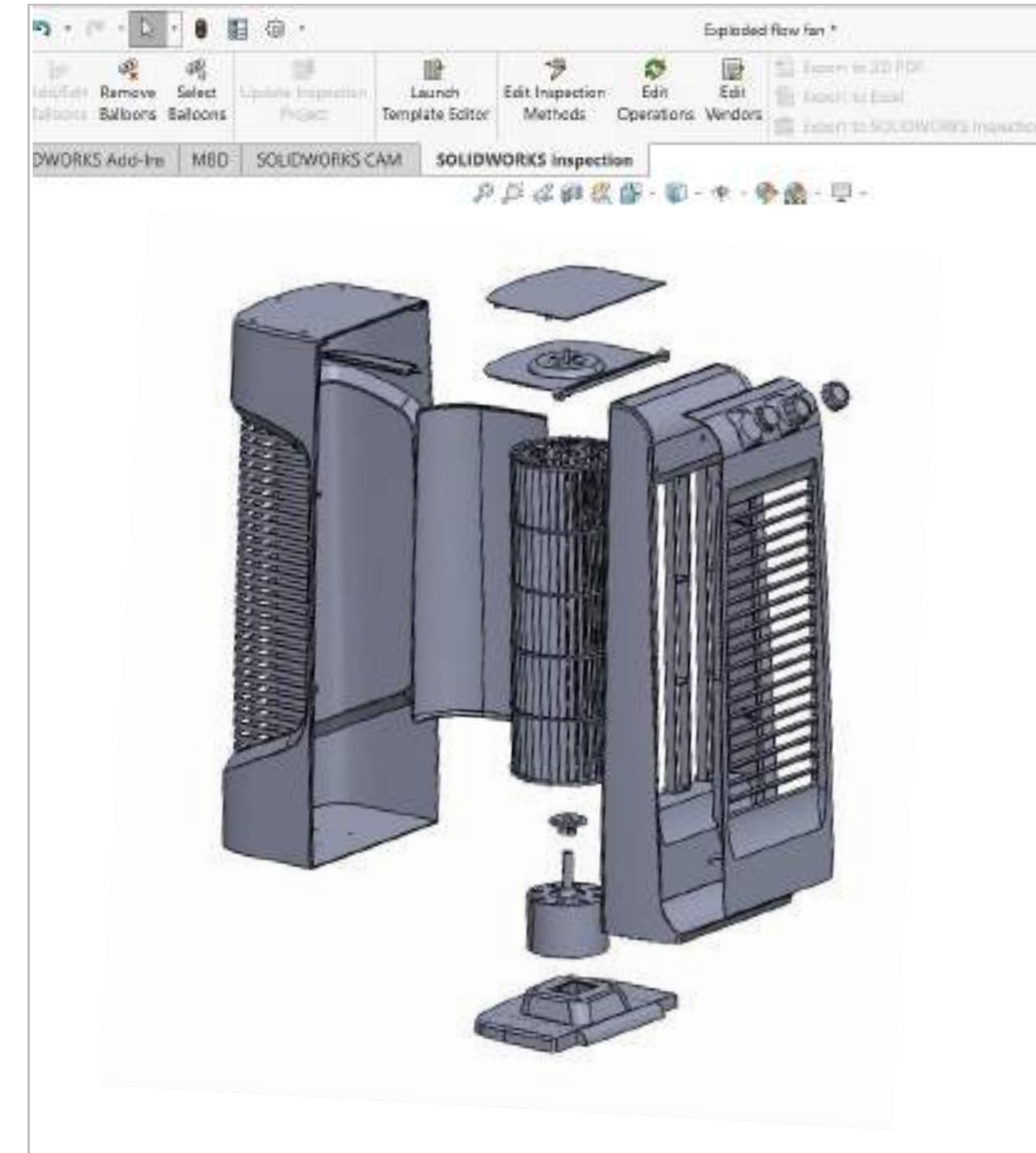

03

3D CAD Modeling and Component Assembly



04

Prototyping and Testing



# OUR PROCESS

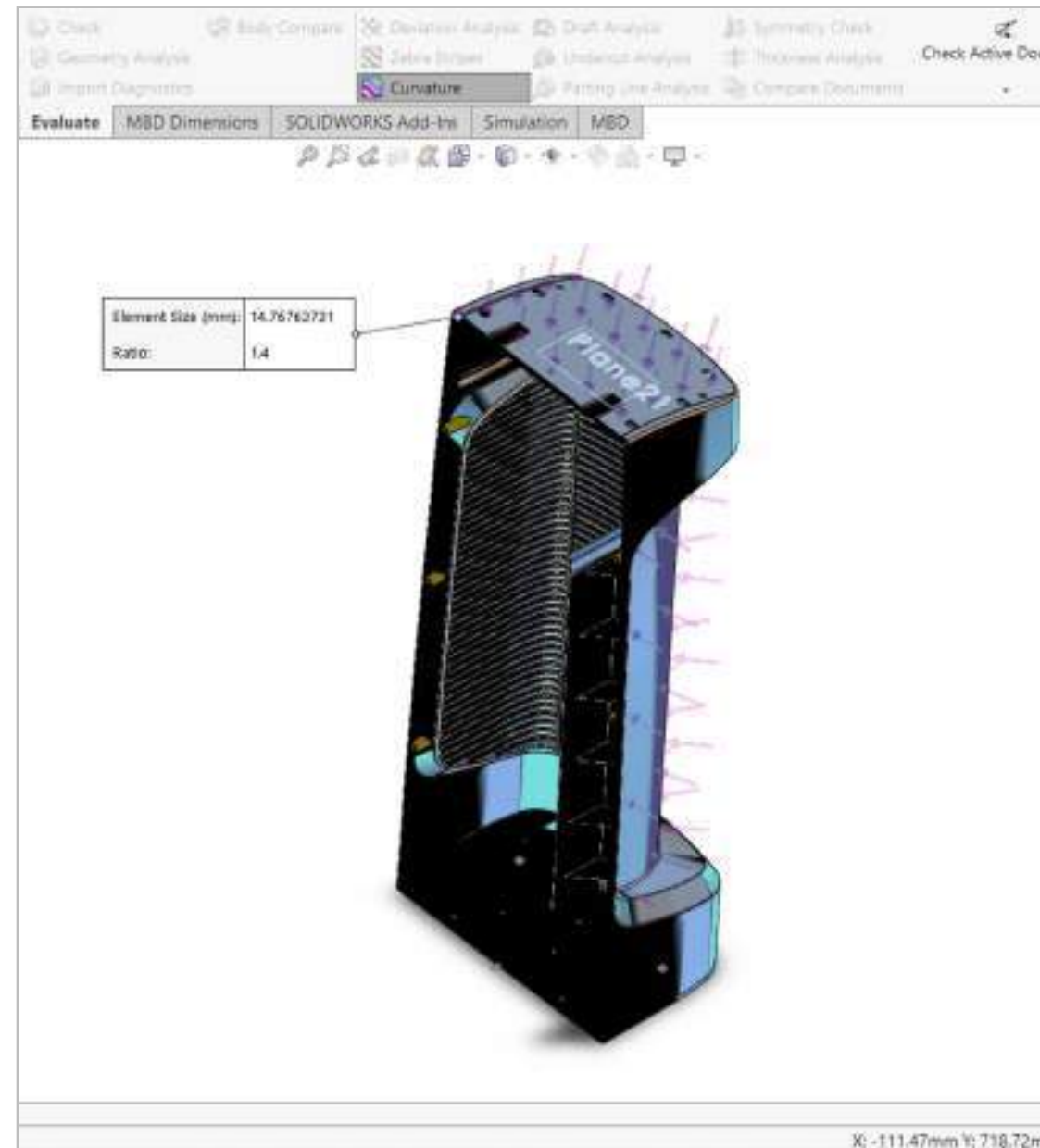

05

Value Engineering

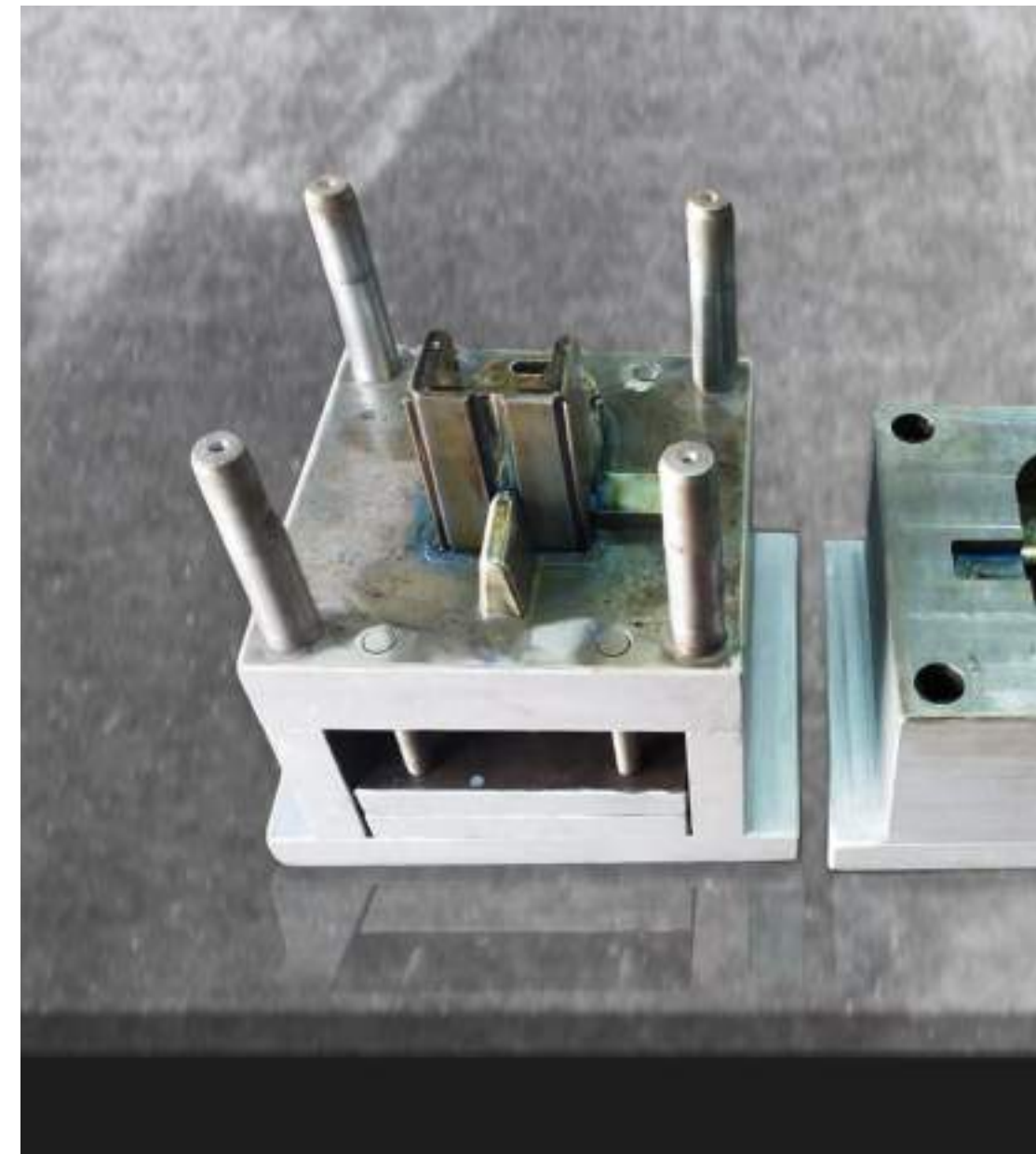

06

Tool Die and Mold Design



07

Packaging and Branding

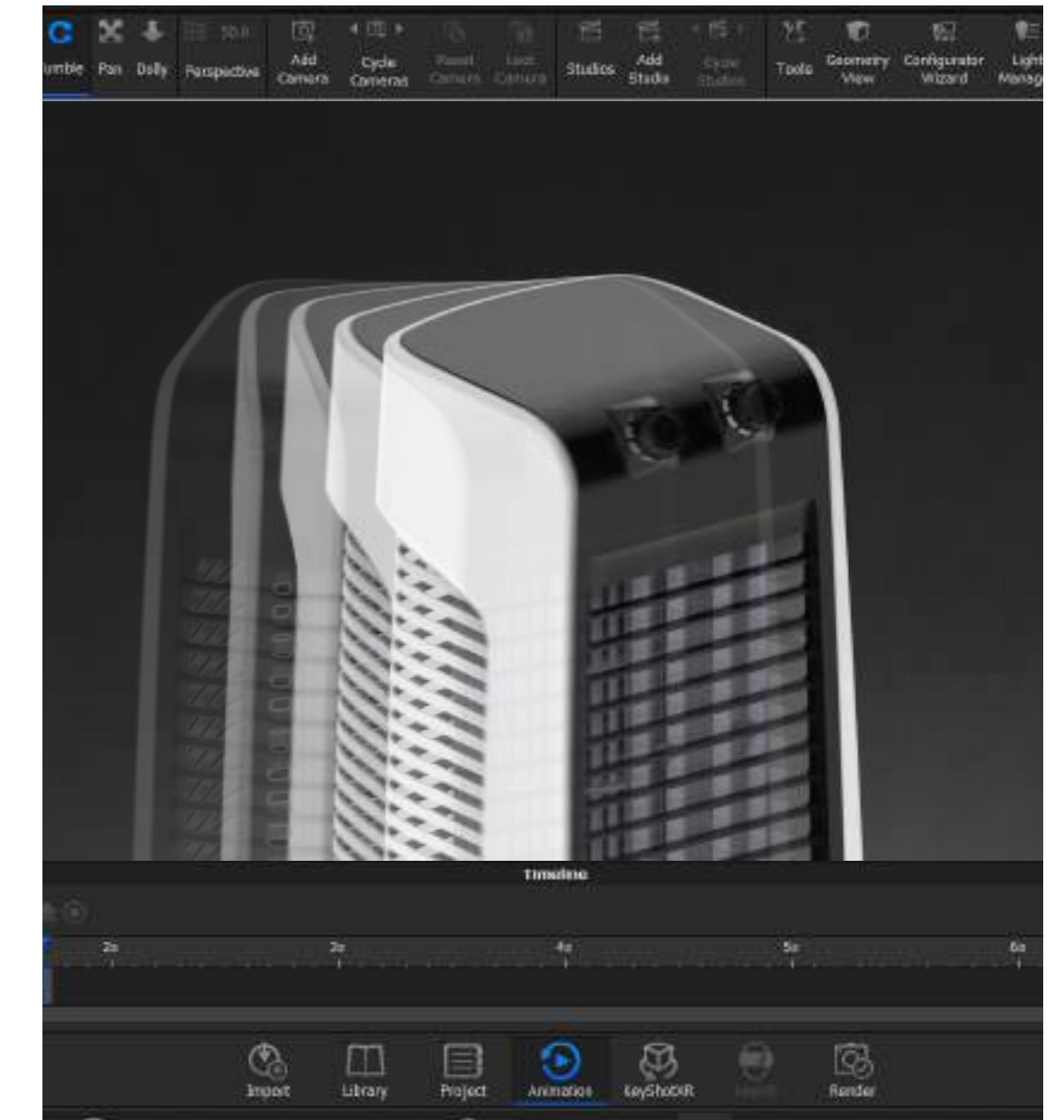

08

Animation



# PRODUCT CATALOGUE



01

Home Appliances

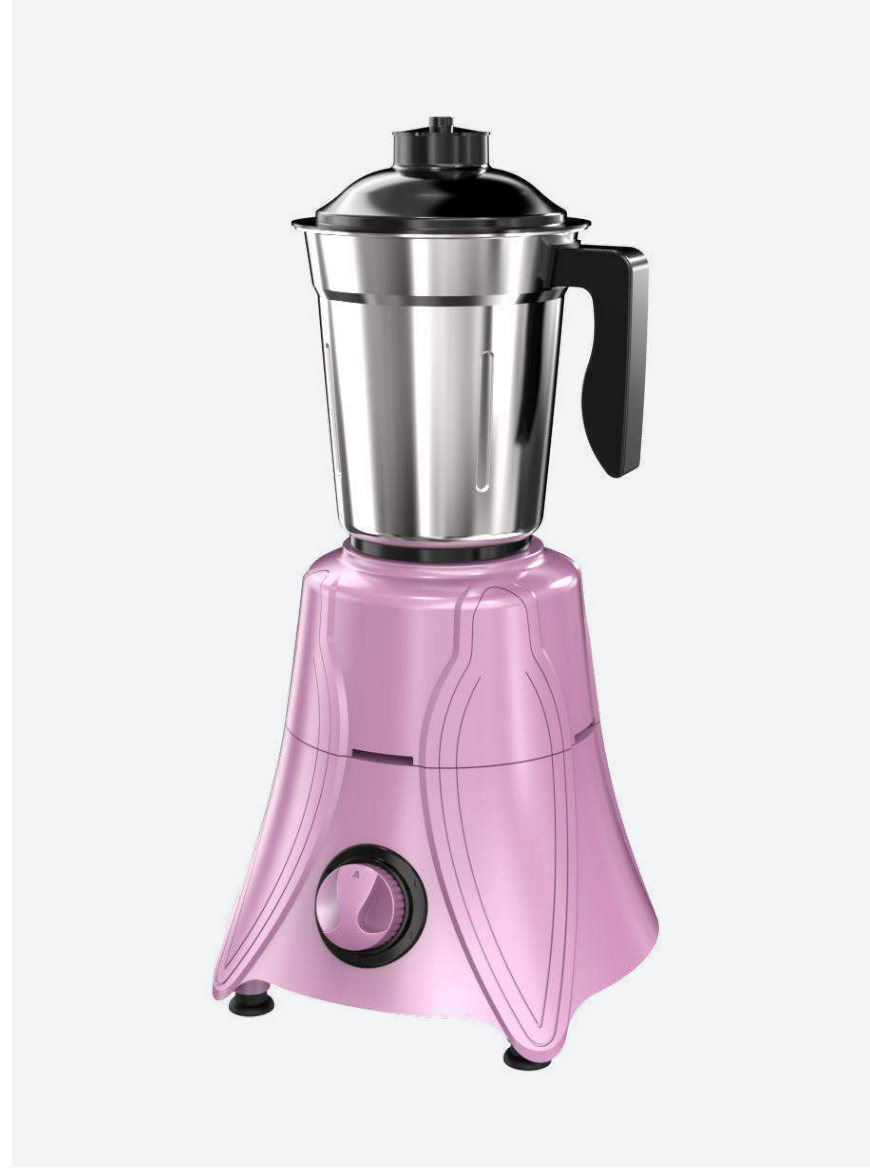

02

Kitchen Appliances



03

Industrial Products



04

Outdoor Products

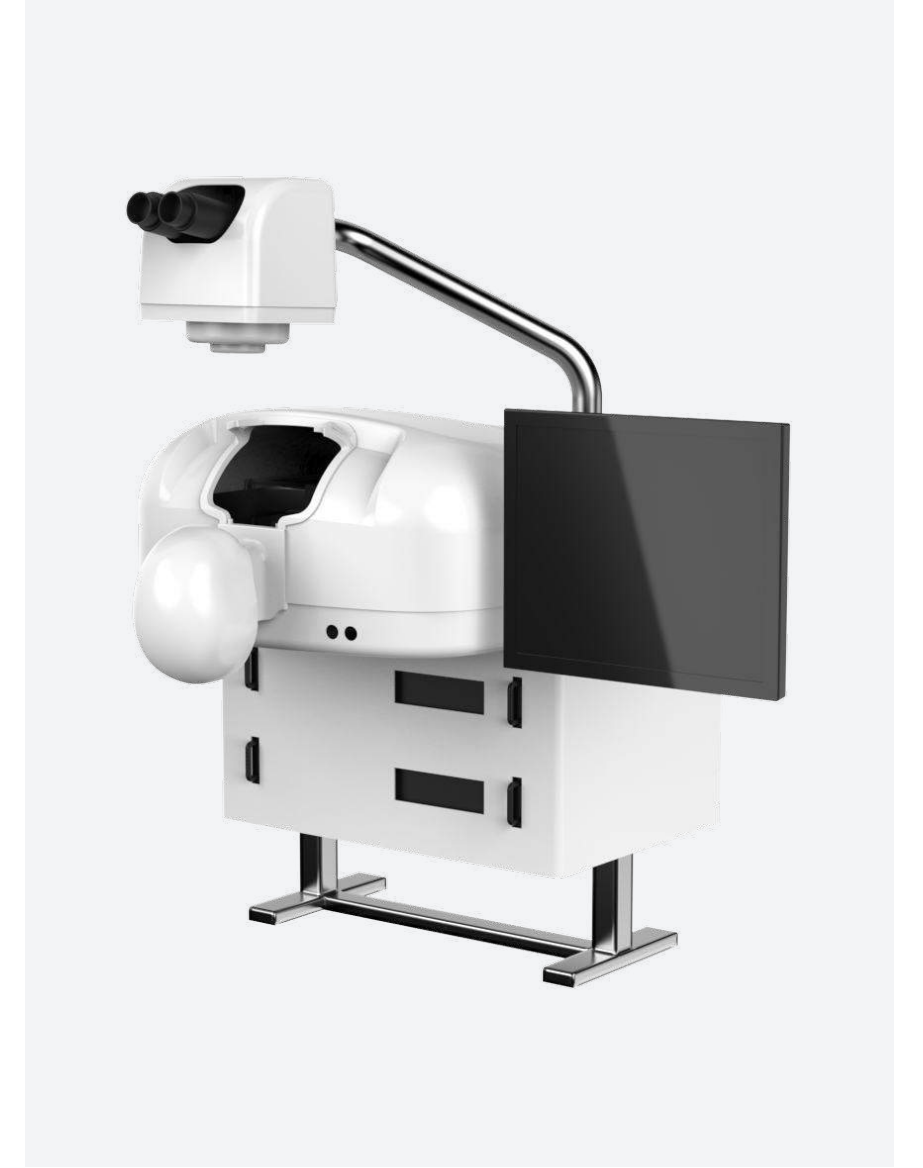

05

Healthcare Products



# VITAL PETAL

Vital Petal is a premium ceiling fan with a shank cover designed like a petal, adding natural beauty to any space. Its elegant chrome finish enhances its premium appeal, making it a statement piece in modern interiors. Experience both style and functionality with Vital Petal, where exquisite design meets superior performance.



**Premium**

**Elegant**



**Minimal**

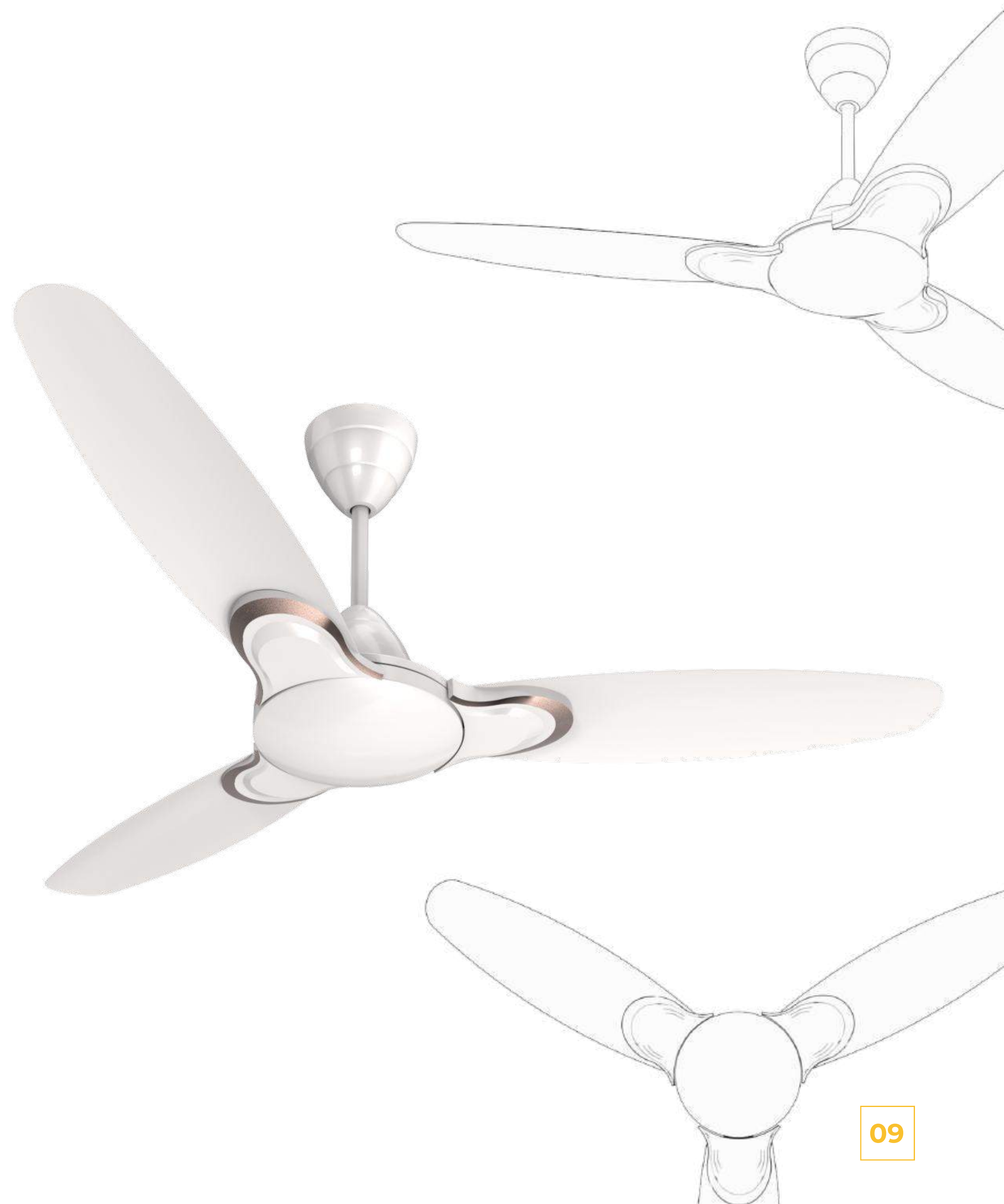



# ELLIPSE

This tower fan has a well-composed form and tranquil character to look at. The knobs match with the front trim in color. The trim adds as an assortment to the overall aesthetics. It also supplements the outlet panel which is curved and large in size allowing maximum angle of air flow.

Product launched in market



Composed

Homely



Simple

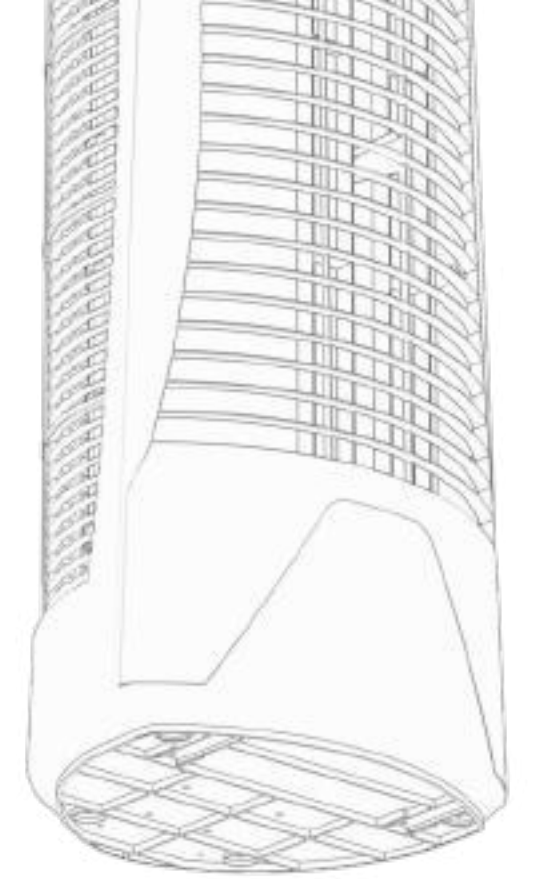
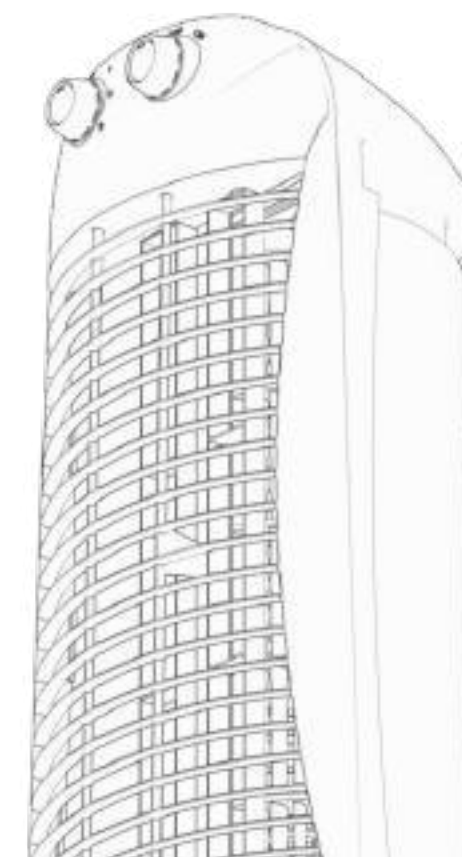



# ZUERST

Zuerst is a water heater with a minimalist form. This geyser is a premium range product and is the first product from the client company imbibing AI. The user can control the parameters such as temperature via the display and soft touch button panel at the front. Chrome trims are added to raise the superior appearance of the product while fitting beautifully into the aesthetics of home.



Minimal

Premium



Professional

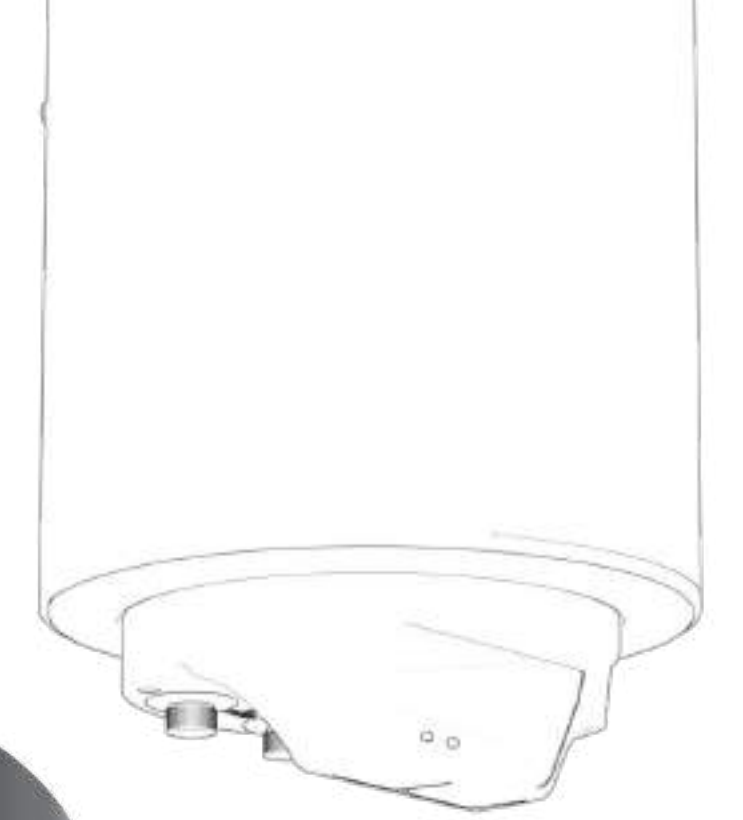



# TREBLE

Treble is a ceiling fan made for the premium segment. It has gold finished trims added to accentuate the Blades. Designs inspired from Mandala art done with premium quality screen printing runs across the Motor housing as well as the blades.

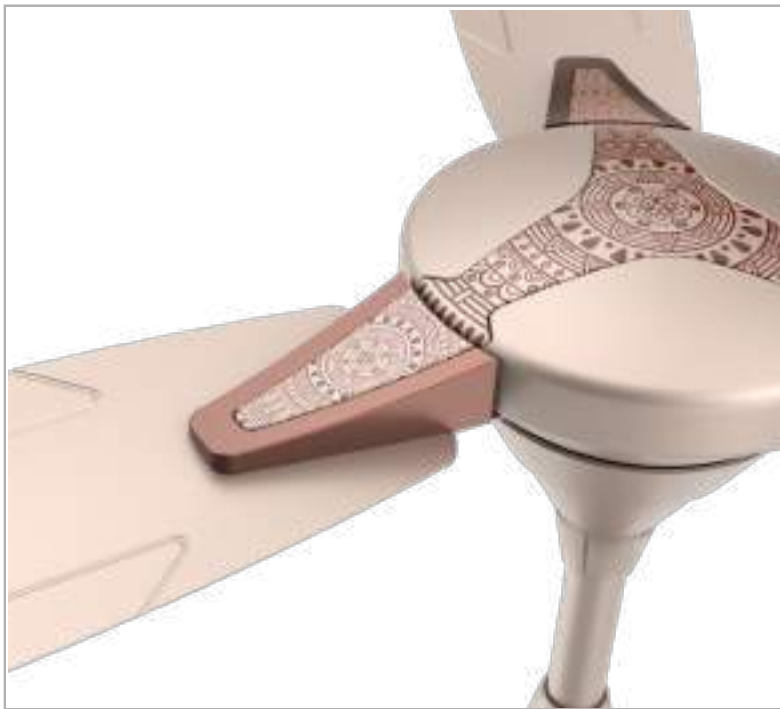

Premium

Decorative

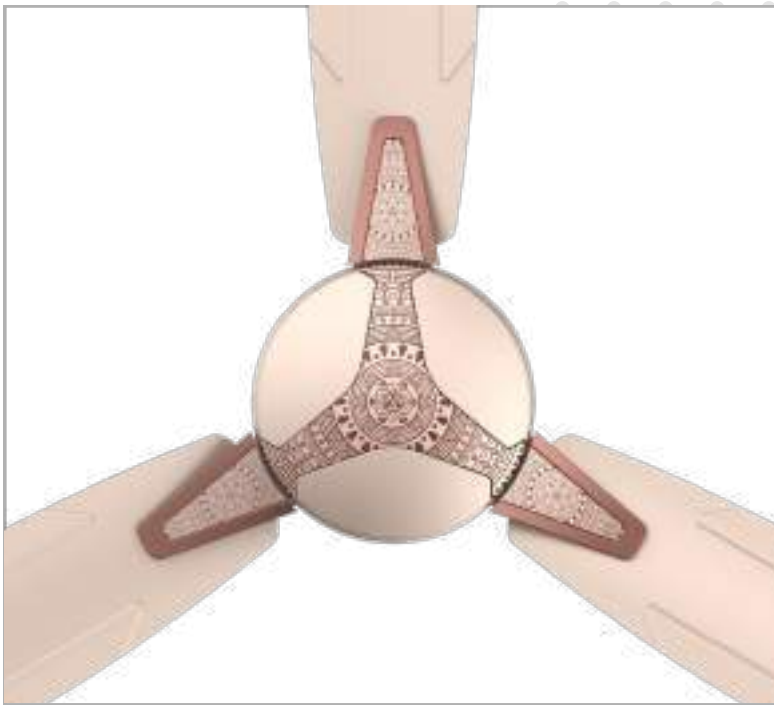

Traditional





# CRAVELOCK

Crave Lock is an ingenious yet straightforward utility device designed to empower users in managing their cravings effectively. With its smart locking technology, Crave Lock allows users to take control by securely locking away tempting treats or snacks within its container.



**Modest**

**Smart**



**Simple**





# HIEN

Hien embodies elegance in bathroom exhaust fans, featuring a sleek design and rhythmic character on its front fascia. It adds sophistication to any bathroom, enhancing aesthetic appeal while efficiently ventilating moisture and odors. Hien offers both style and functionality, making it a perfect upgrade for any bathroom space.



**Dynamic**

**Flowy**



**Elegant**

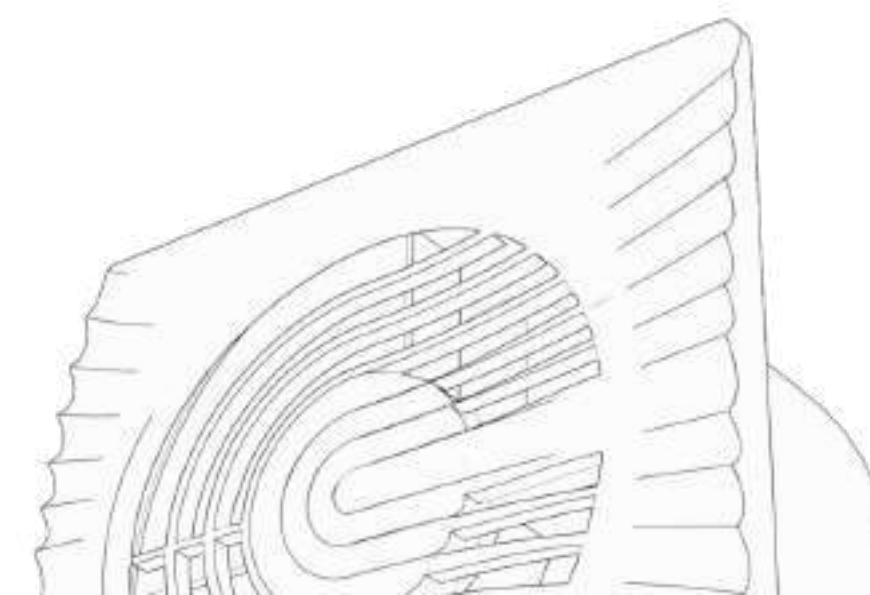
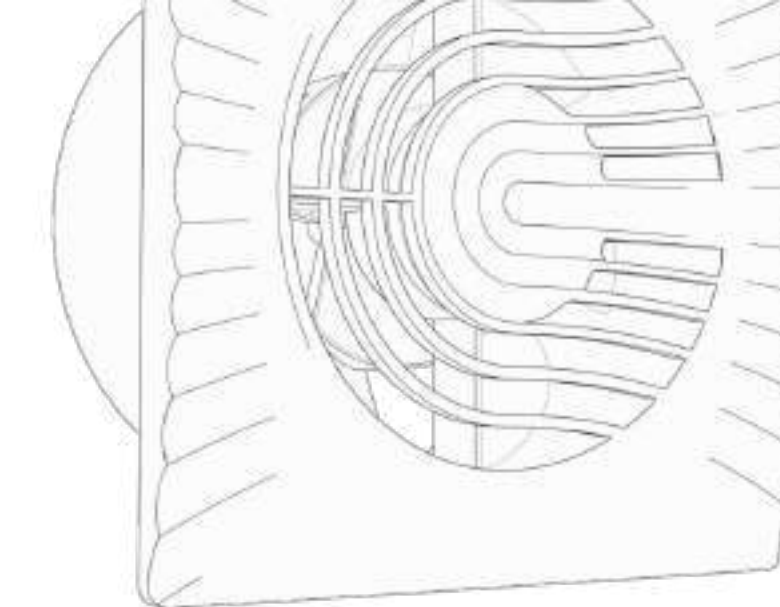



# ZUVI

Zuvi is a sleek and elegant water purifier designed to enhance any kitchen, whether on the wall or countertop. Featuring smart dispensing functions and improved functionality for a superior user experience, Zuvi delivers clean, purified water with style and convenience.



**Smart**

**Clean**



**Classy**





# TULIP

Tulip is a mixer grinder inspired by the delicate curves of the tulip flower, giving it a feminine and organic character. This unique design sets it apart from conventional mixers in the market, offering both elegance and functionality in one appliance.



**Organic**

**Feminine**



**Unconventional**

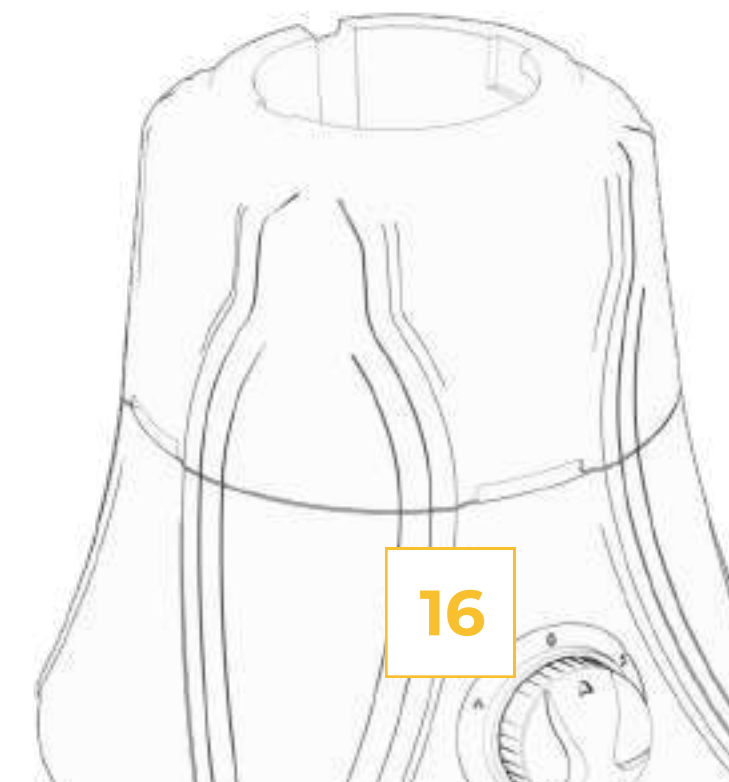
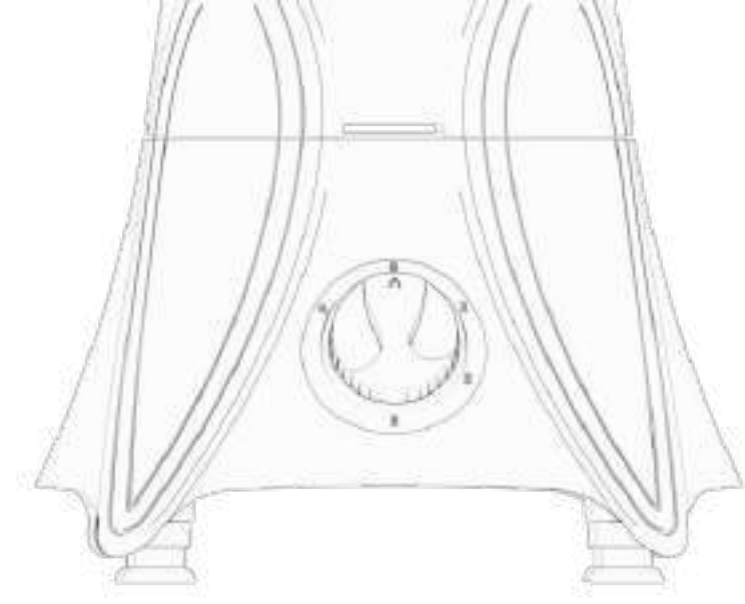



# VESPA

Versatilo is a mixer grinder with IOT integration making it a perfect companion in the kitchen. Its display screen provides real-time updates and parameter adjustments. With top-notch performance and sleek components, it enhances kitchen aesthetics



**Classy**

**Bold**



**Unique**

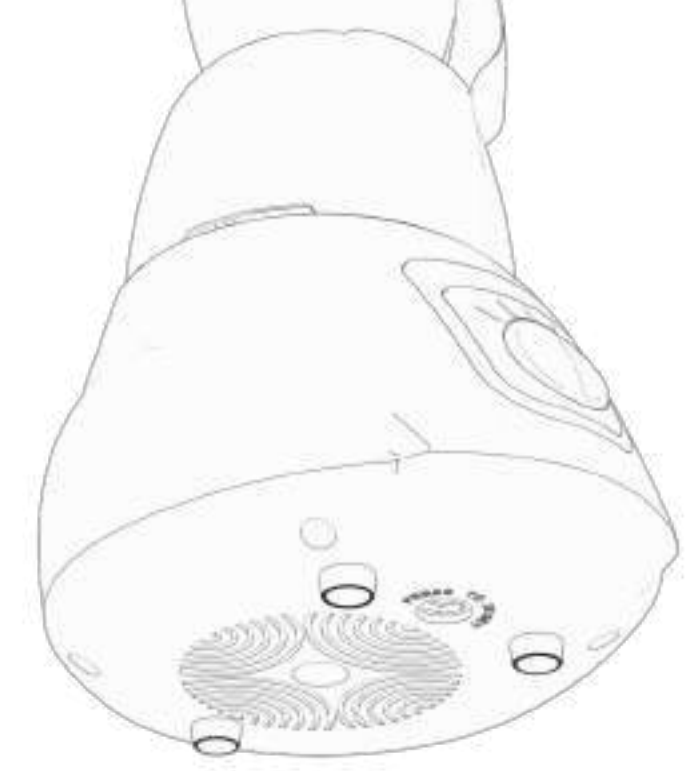



# VERSATILIO

Versatilo is a mixer grinder with IOT integration making it a perfect companion in the kitchen. Its display screen provides real-time updates and parameter adjustments. With top-notch performance and sleek components, it enhances kitchen aesthetics



**Smart**

**Robust**



**Exclusive**

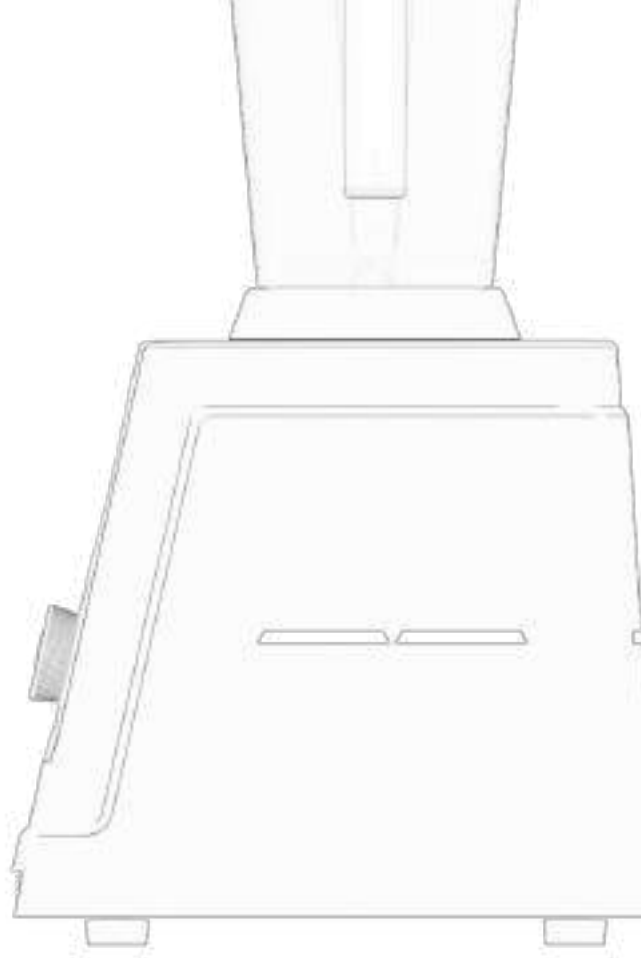



# ACUTEOR

Acuteor is a premium juicer mixer grinder (JMG) renowned for its innovative design and superior functionality. Its uniquely crafted top assembly ensures effortless operation, distinguishing it from other appliances in the market. Experience convenience and efficiency like never before with Acuteor

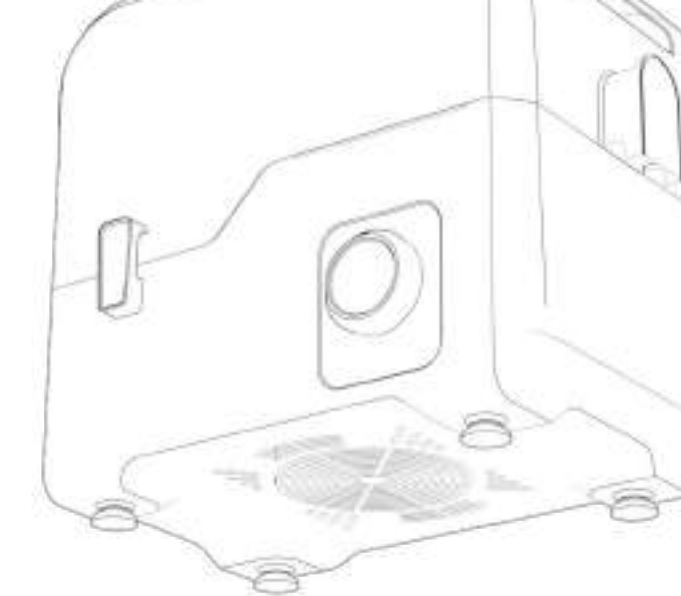

**Versatile**

**Robust**



**Premium**

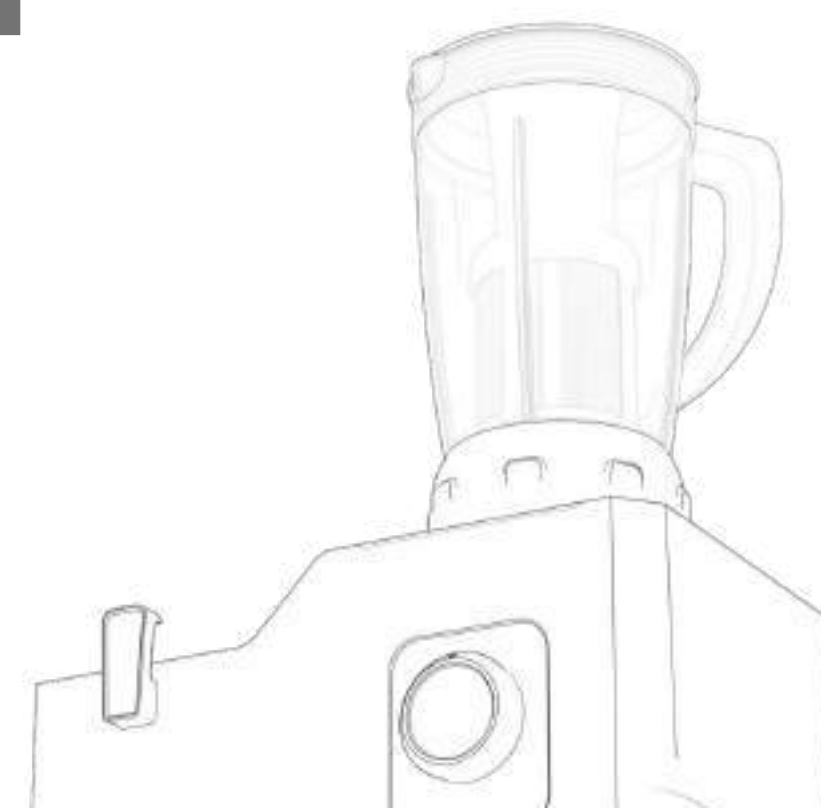



# DEMETER

Demeter is designed to be a sleek coffee maker with a viewpoint to be aesthetically minimal as well as modish. The metallic panels throughout the form gives a premium appearance without being too flashy. Demeter has IOT integration coupled with a large display with touch controls to prepare the bespoke and favorite coffee with ease.

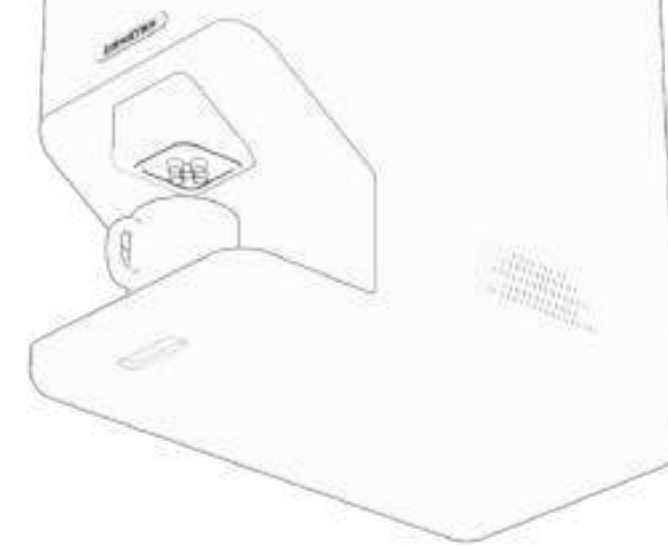

**Sleek**

**Minimal**



**Professional**

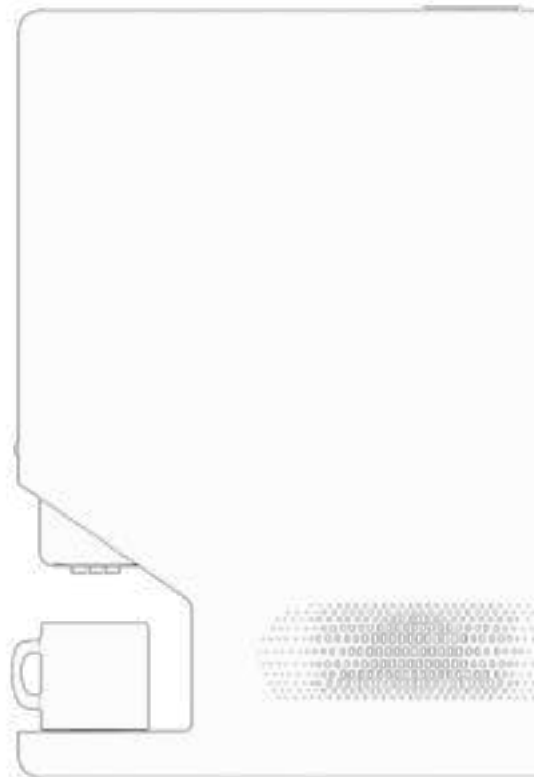



# AUGMENTO

Augmento redefines versatility as the ultimate industrial pen. Combining pens, markers, blades, and scoring tools in one compact design, it simplifies tasks. Users replace cluttered toolboxes with Augmento's streamlined functionality, perfect for marking, cutting, or scoring in any industrial setting.



**Industrial**

**Techy**



**Versatile**

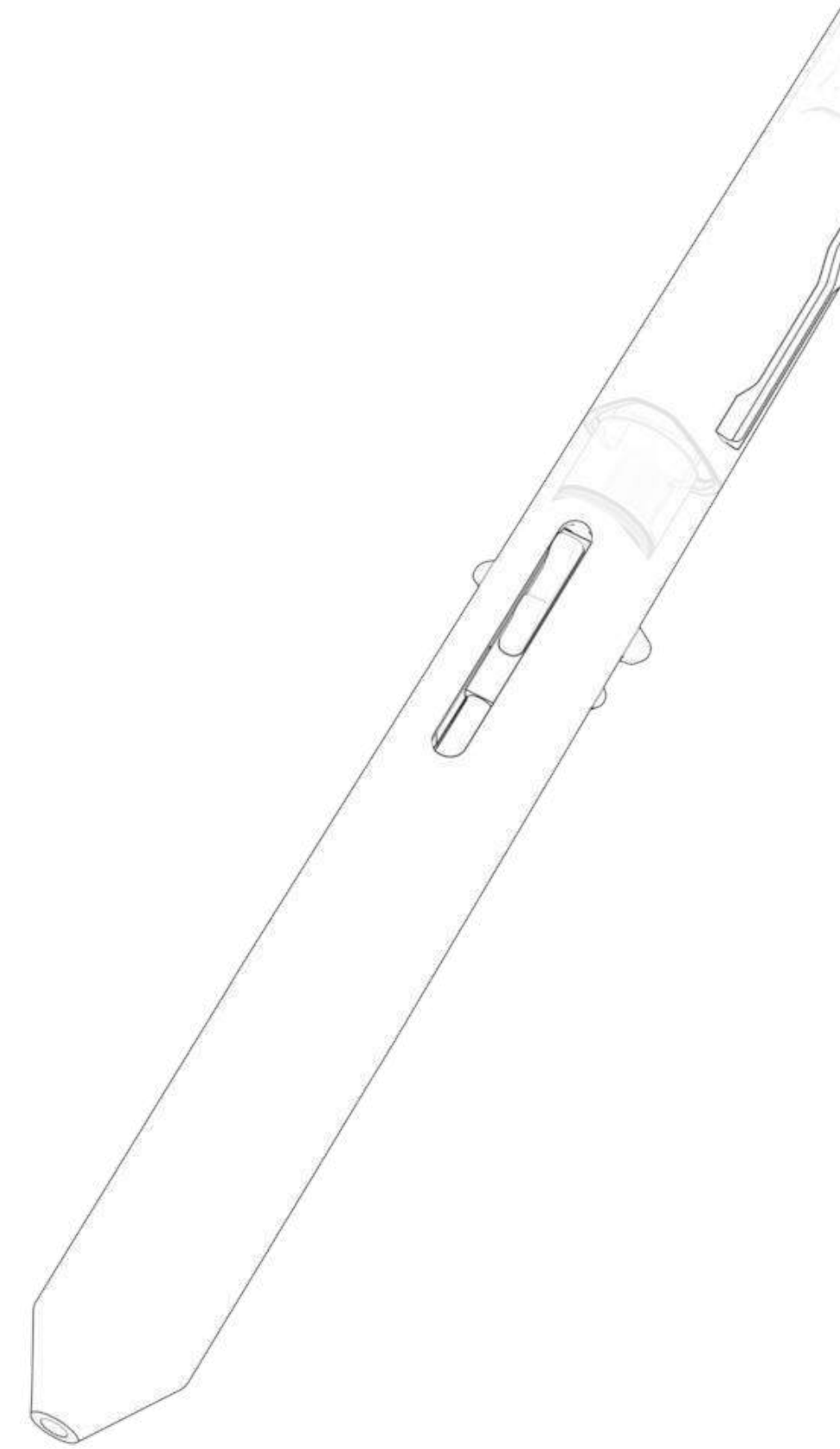
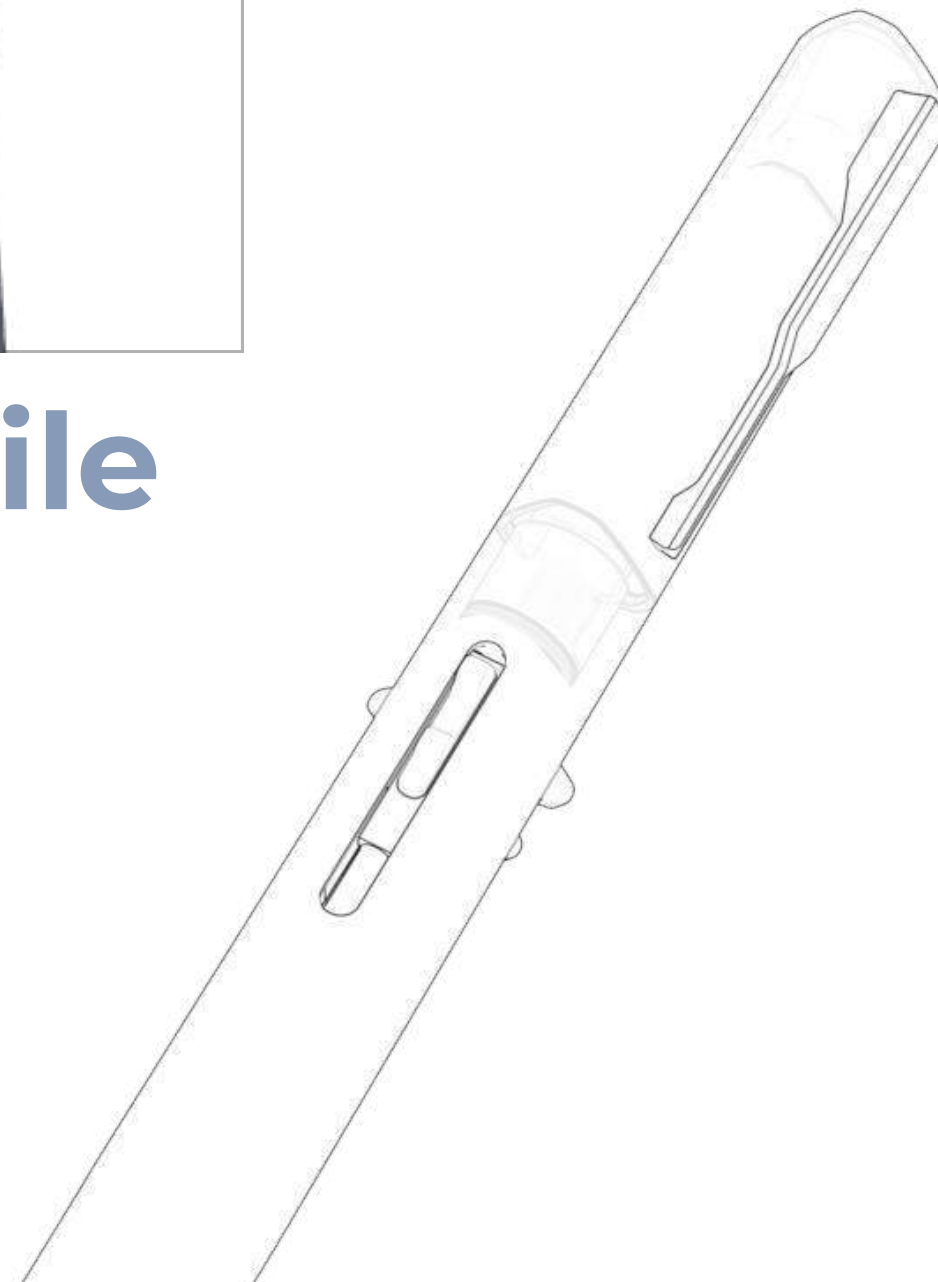

Industrial products

# SKANNA

Skanna is an industrial thermal scanner crafted for durability and user comfort. Its robust design ensures reliability, while the ergonomic grip provides ease of use. Experience accurate temperature readings with confidence in any industrial setting.



**Robust**

**Sporty**



**Industrial**

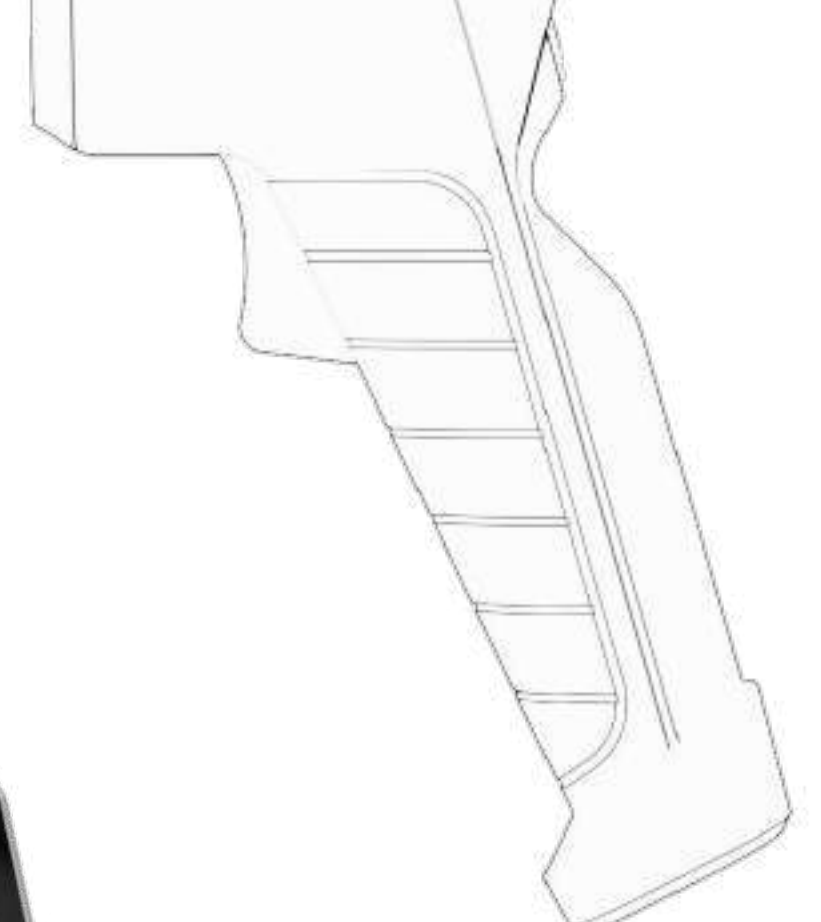
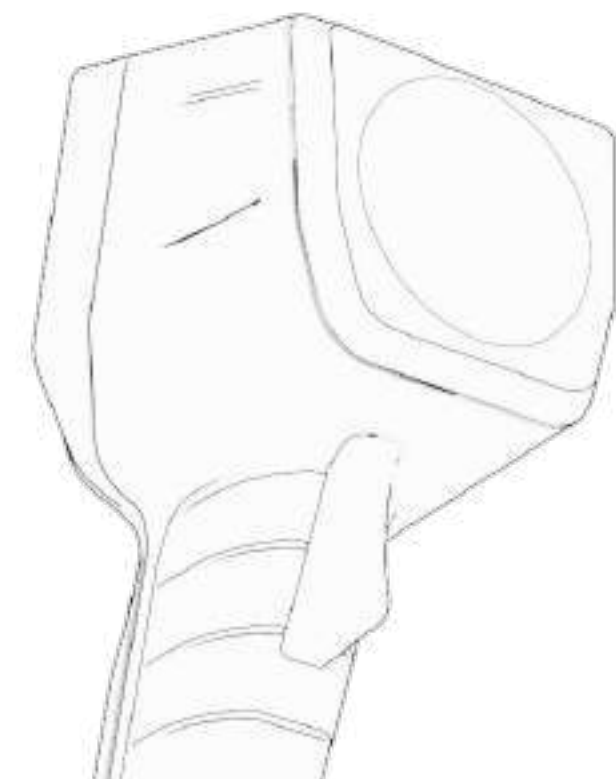



Industrial products

# MYRO

Myro is an industrial painting robot meticulously crafted to aid humans in large-scale painting endeavours while alleviating their workload. Engineered for efficiency and precision, Myro significantly enhances productivity and delivers high-quality results, revolutionizing industrial painting processes.



**Heavy-duty**

**Industrial**



**Resilient**

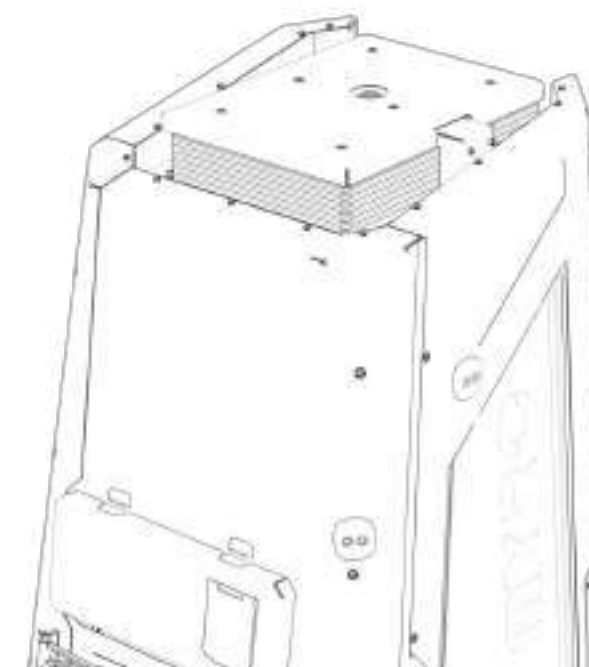



# CHARGEGRID

Chargegrid is an innovative EV Charger which is not just a practical solution for electric vehicle owners but also a statement of forward-thinking design. With its sleek and intelligent design, Chargegrid sets the standard for future charging technology, offering convenience and sophistication in one package.



**Minimal**

**Futuristic**



**High-tech**

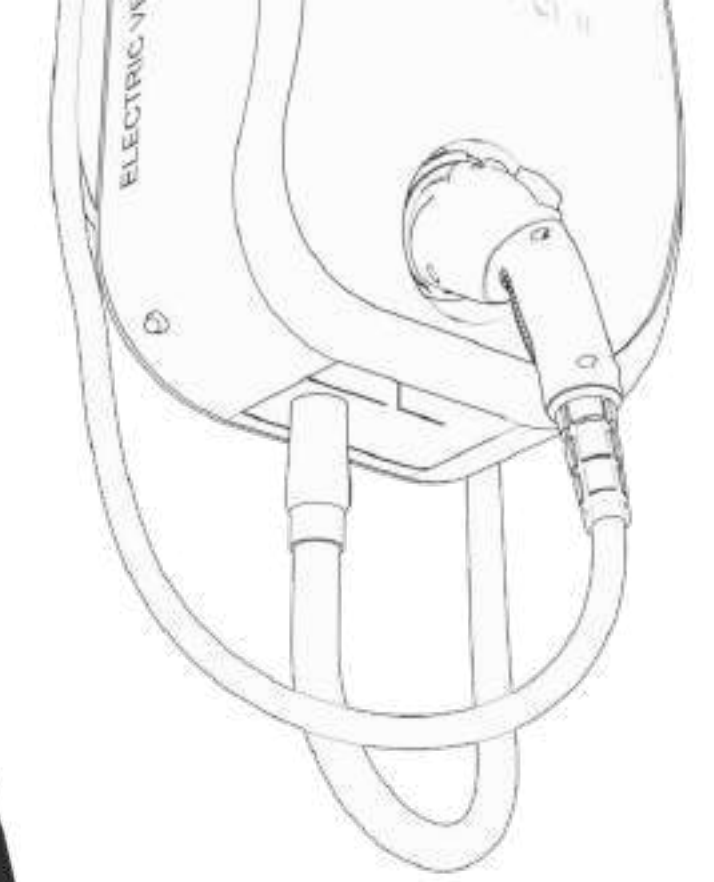



# T-BULB

T-Bulb is a premium, horizontally-designed lighting solution that seamlessly blends elegance with durability. Emitting a soft, warm glow, this sleek bulb enhances any space it illuminates while minimizing energy consumption. Versatile and stylish, the T-Bulb redefines lighting sophistication.



**Elegant**

**Premium**



**Unconventional**

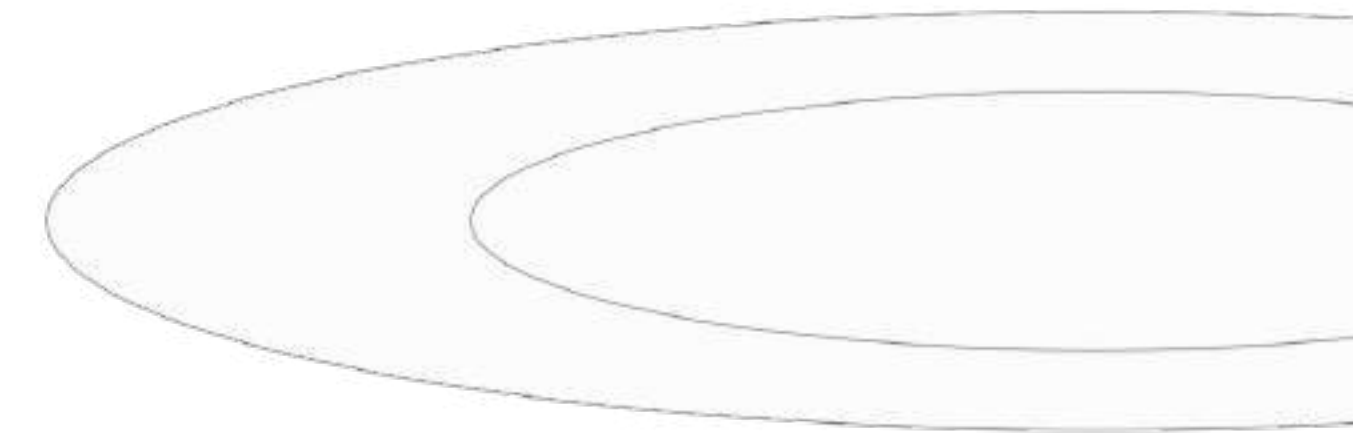
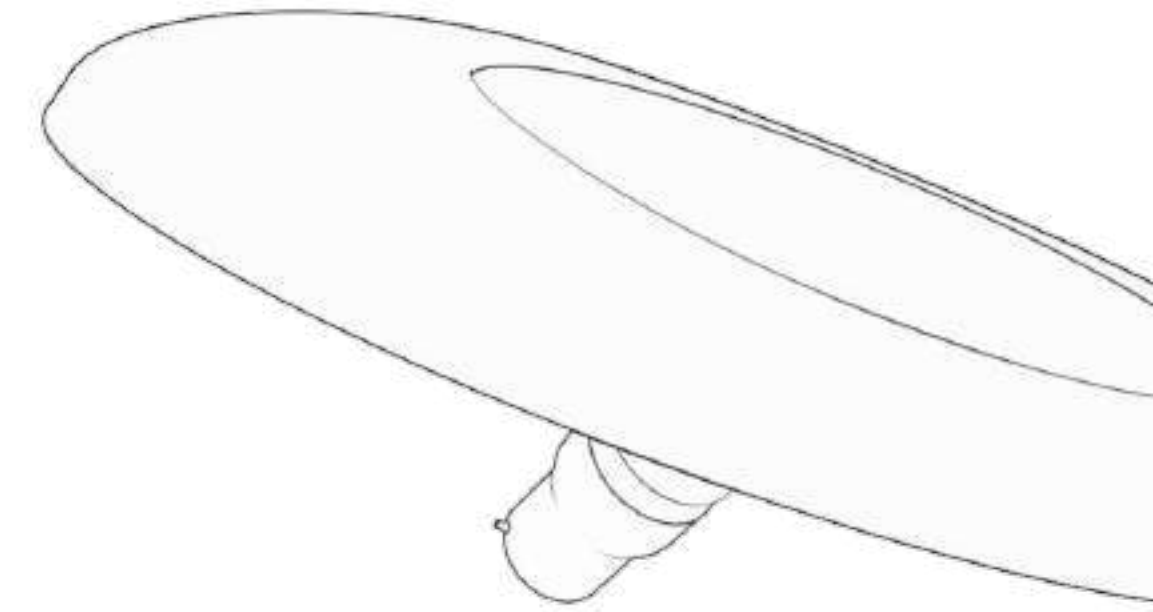

**SMART SWITCH**



**DAN**



**ROUND SPIKEGAURD**



**CEILING ROSE**



**BULB HOLDER**



**DING DONG BELL**





**BULB HOLDER**



**TUBELIGHT**

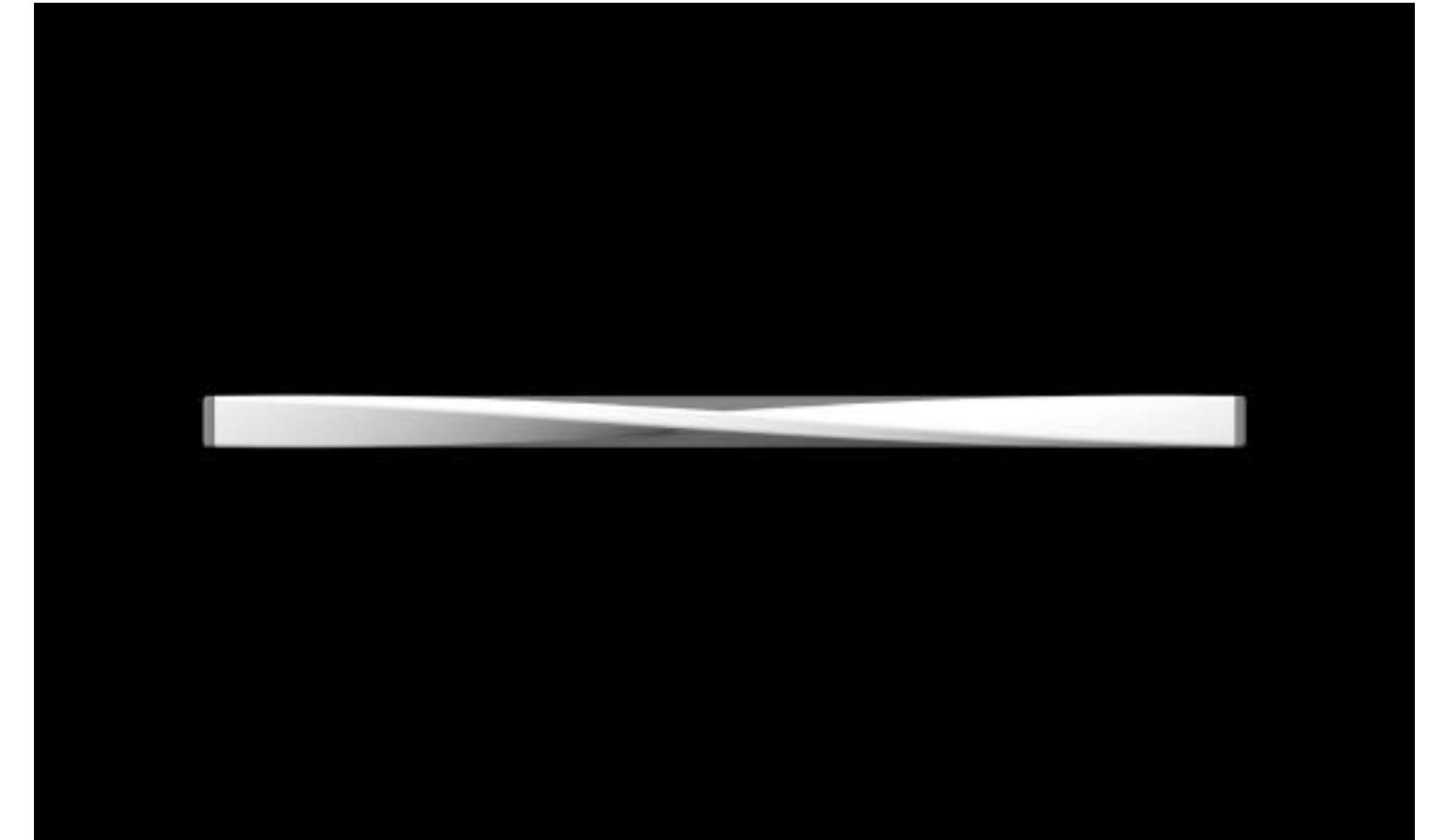

**CEILING LIGHTING**

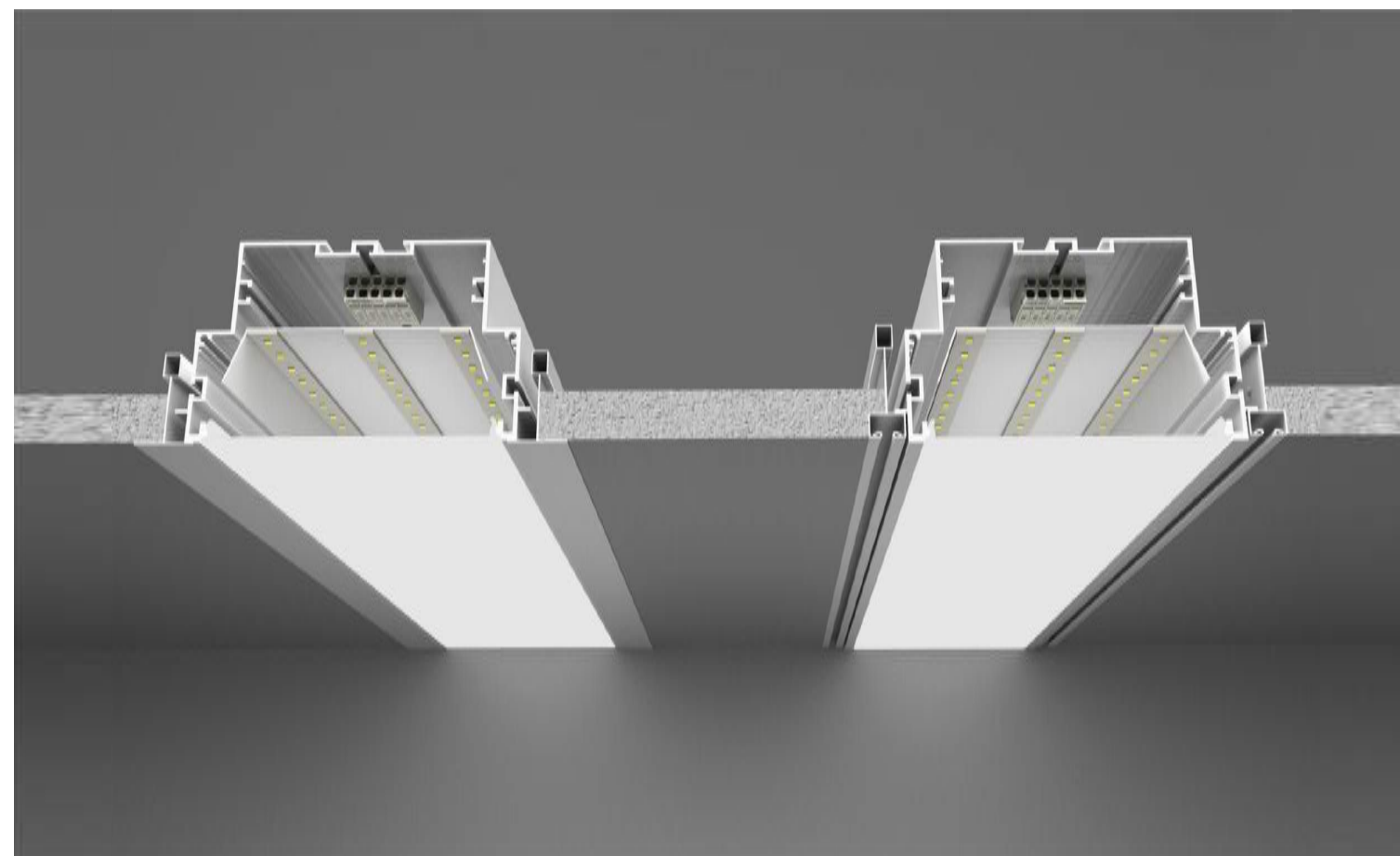

**TUBELIGHT**

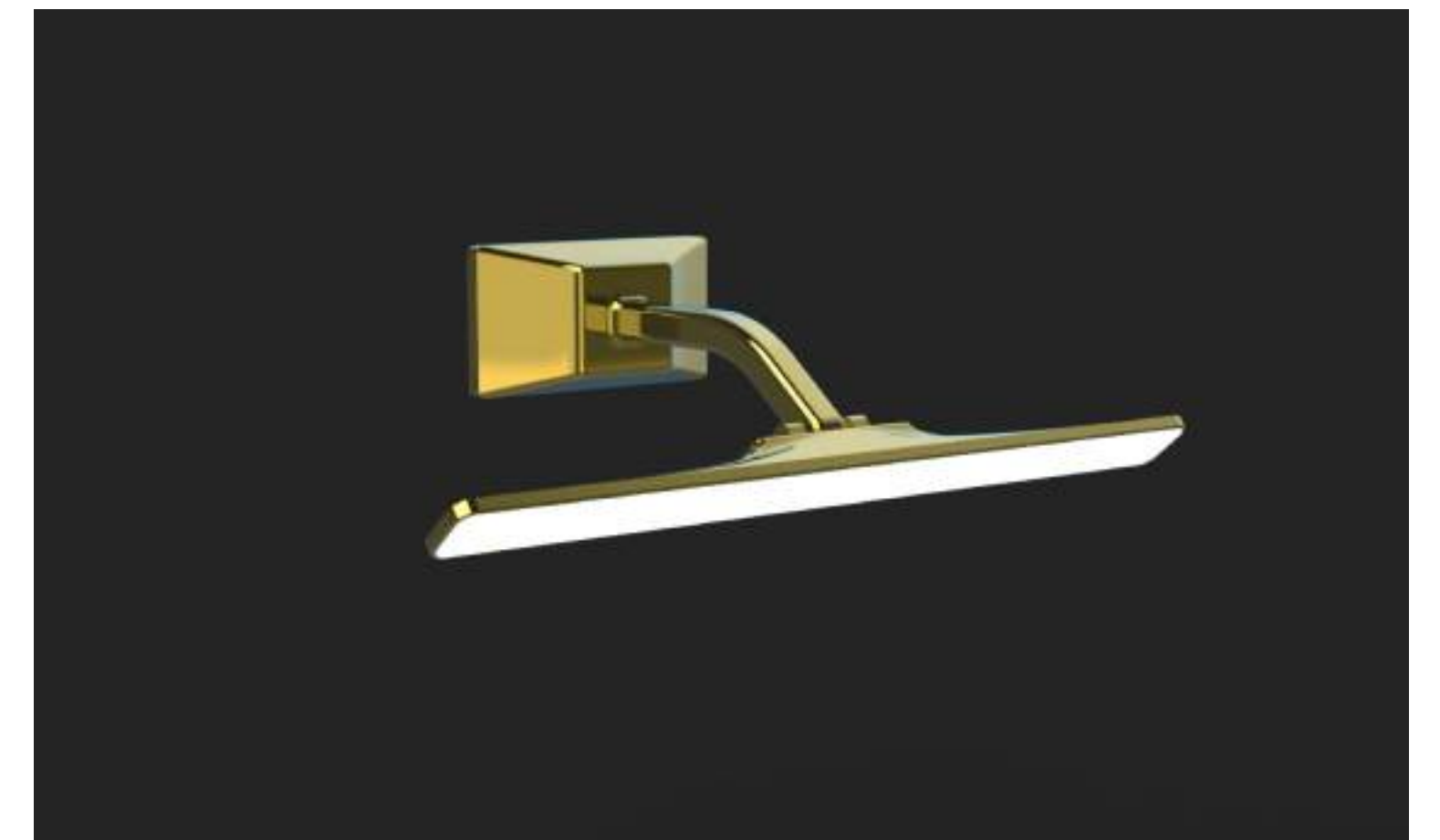

# HELP ME SEE

## What?

It is a PESS unit for cataract surgery.

## Why?

The existing unit is bulky, non-portable and expensive to transport.

## How?

Creating a portable knock-down unit, downsizing, optimizing skeleton frame and stand.



# PROBLEMS



## PHYSICAL UNLOADING

Calibration issues  
Wear and tear



## FORKLIFT UNLOADING

High cost  
Time consuming  
Unavailability of forklift at all sites



## PORTABILITY

Damage to the outer casing  
Calibration issues  
Wear and tear



# THE CONCEPTS

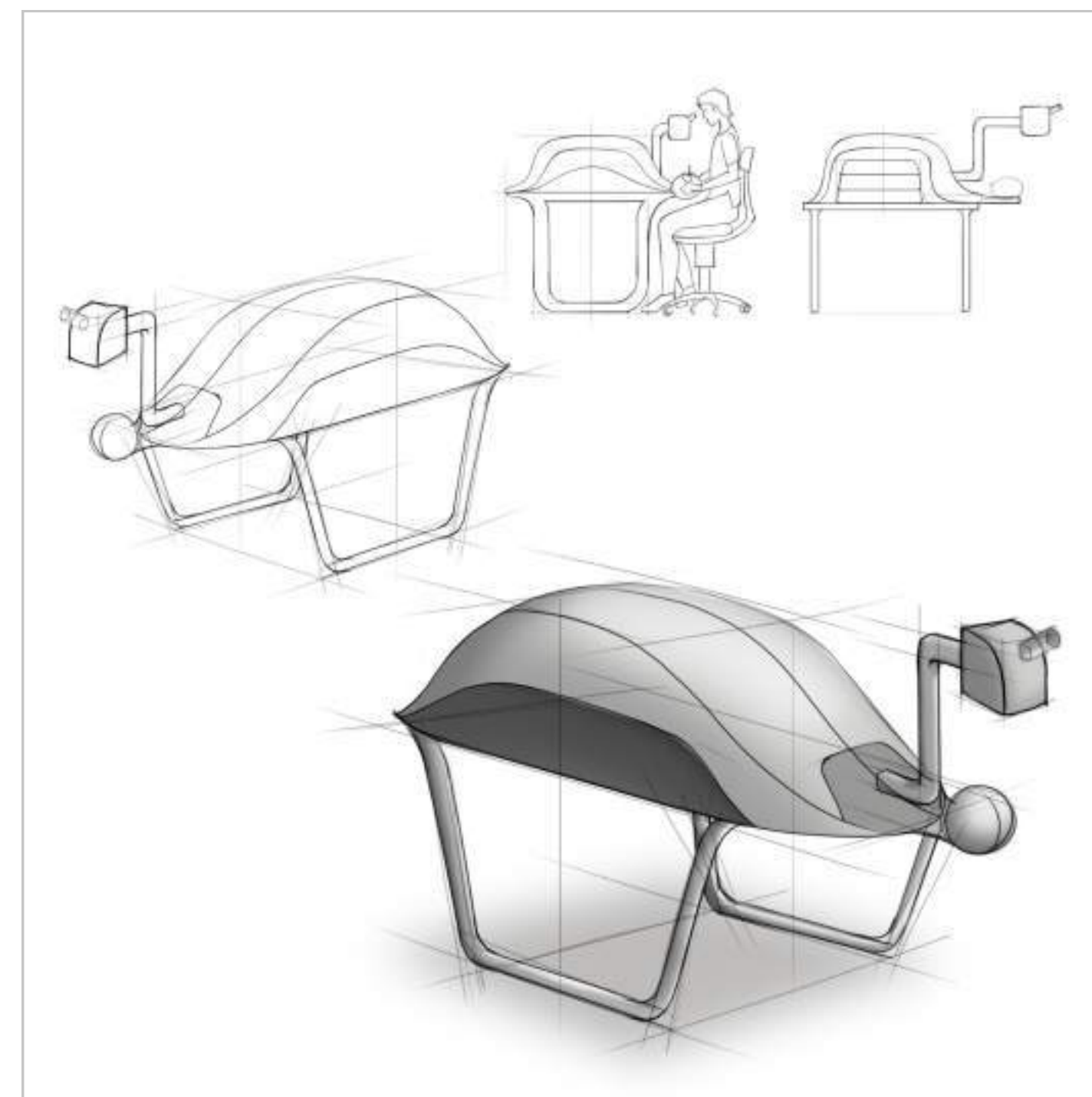
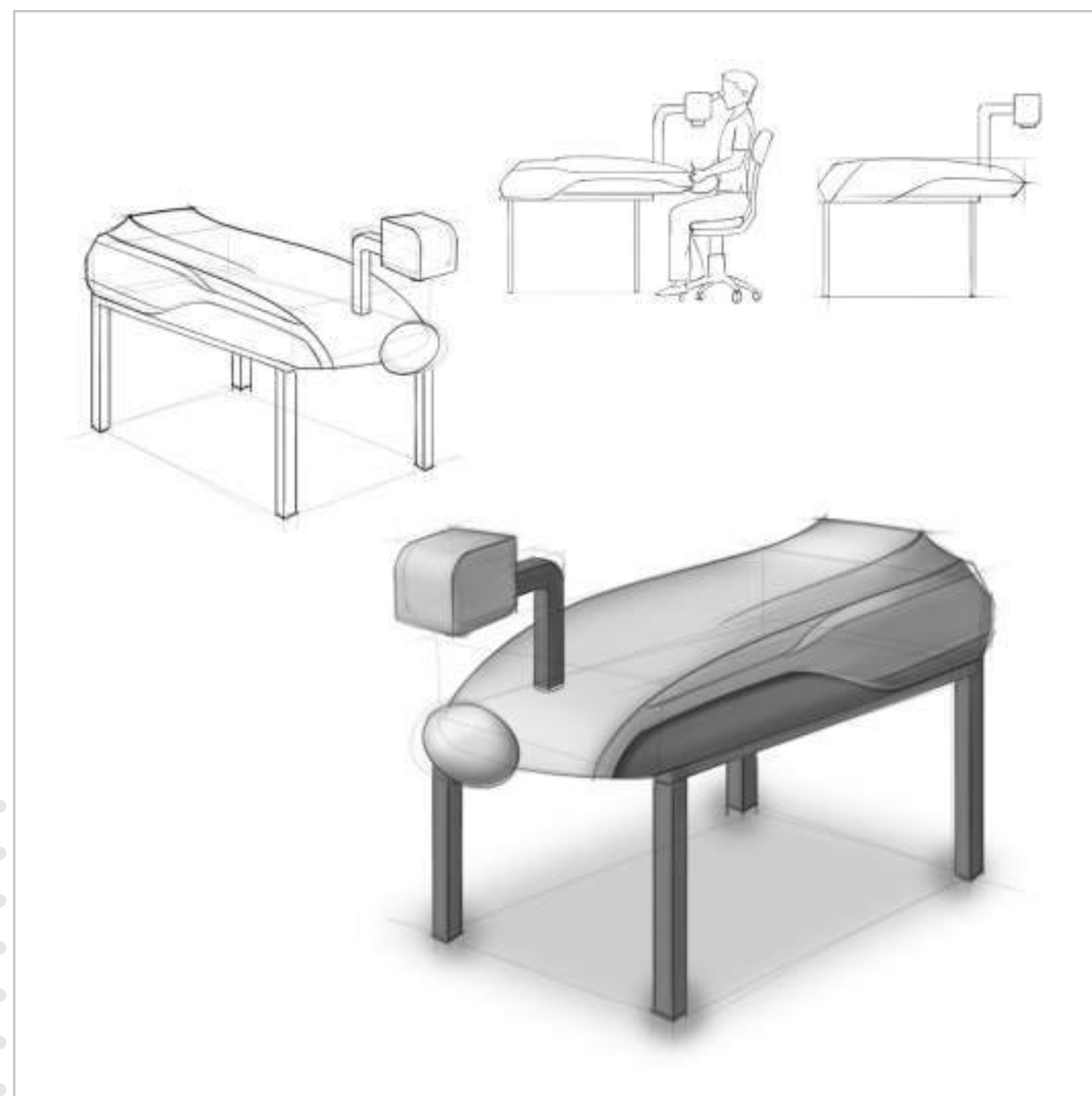



# HELP ME SEE

Can be shipped as baggage as well as cargo. Significant reduction in weight and size without any change in LRUs. Thoughtful modularization to optimise assembly and disassembly time. Ease of assembly by non-engineers



**Compact**

**Modular**



**Reliable**



# EDDY

Eddy is an attachment device. It is devised to be attached to any normal liquid dispenser at the plunger. Automatic dispensing of the content is enabled owing to the inbuilt sensors. This USP of Eddy makes any manual dispenser into a hands free and hygienic dispenser

**Simple**

**Compact**

**Smart**





# SCHNELL

Schnell is an instant water geyser that combines sleek design with minimalistic aesthetics. With its compact and modern appearance, Schnell seamlessly integrates into any space, offering both functionality and style. Schnell's streamlined silhouette, provides hot water instantly whenever you need it.

Sleek

Compact

Composed

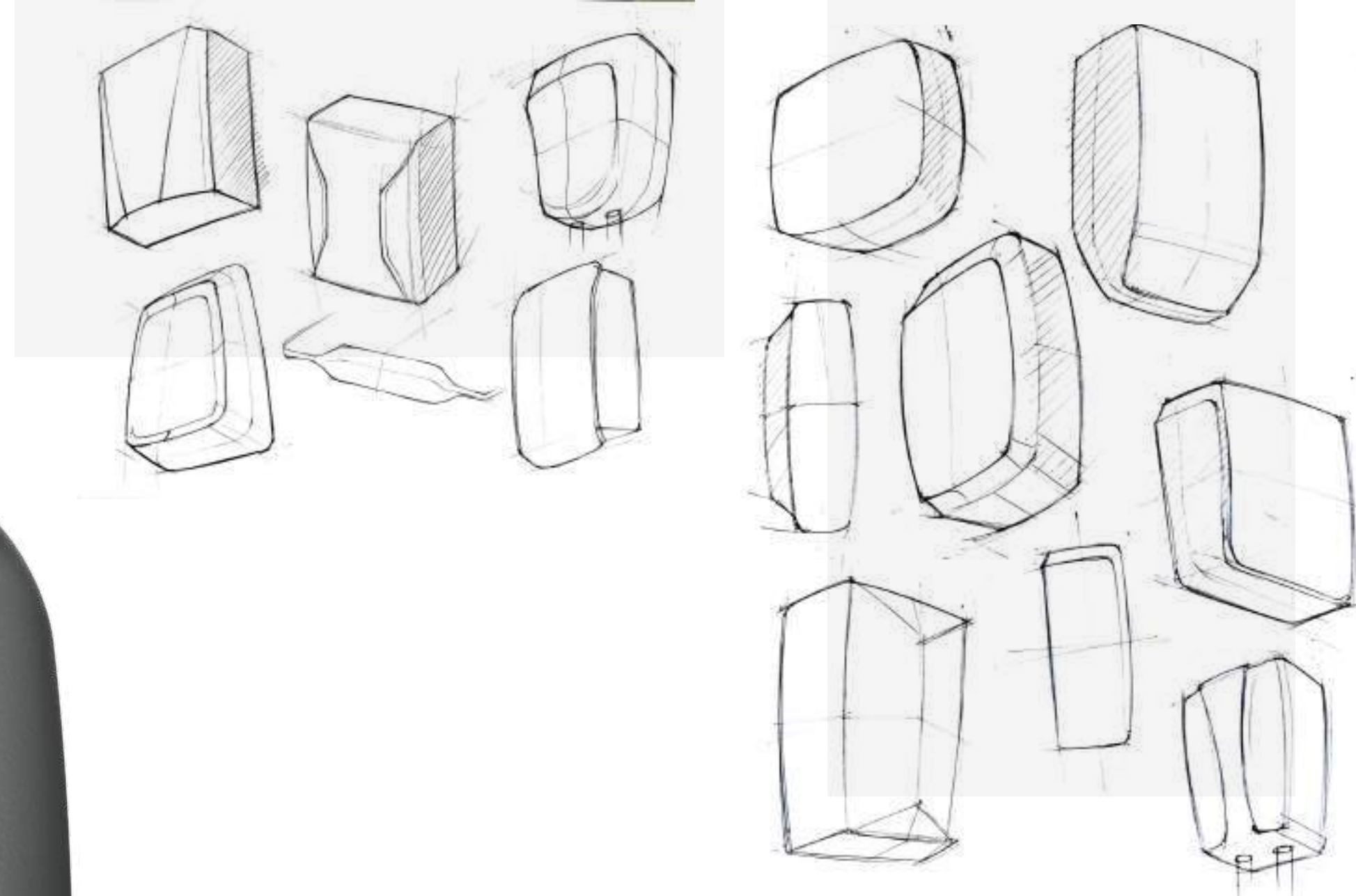



## Product Concept- Consumer Electronics

# DEX

Dex is a desk organizer which includes a clock with speaker, calendar, file holder, lamp, mini drawers, pen holder and a plant holder. This concept empowers users with the freedom to curate, acquire, and seamlessly blend accessories according to their unique preferences, resulting in a fully personalized desk set that truly reflects their individuality.

**Modular**

**Neat**

**Versatile**

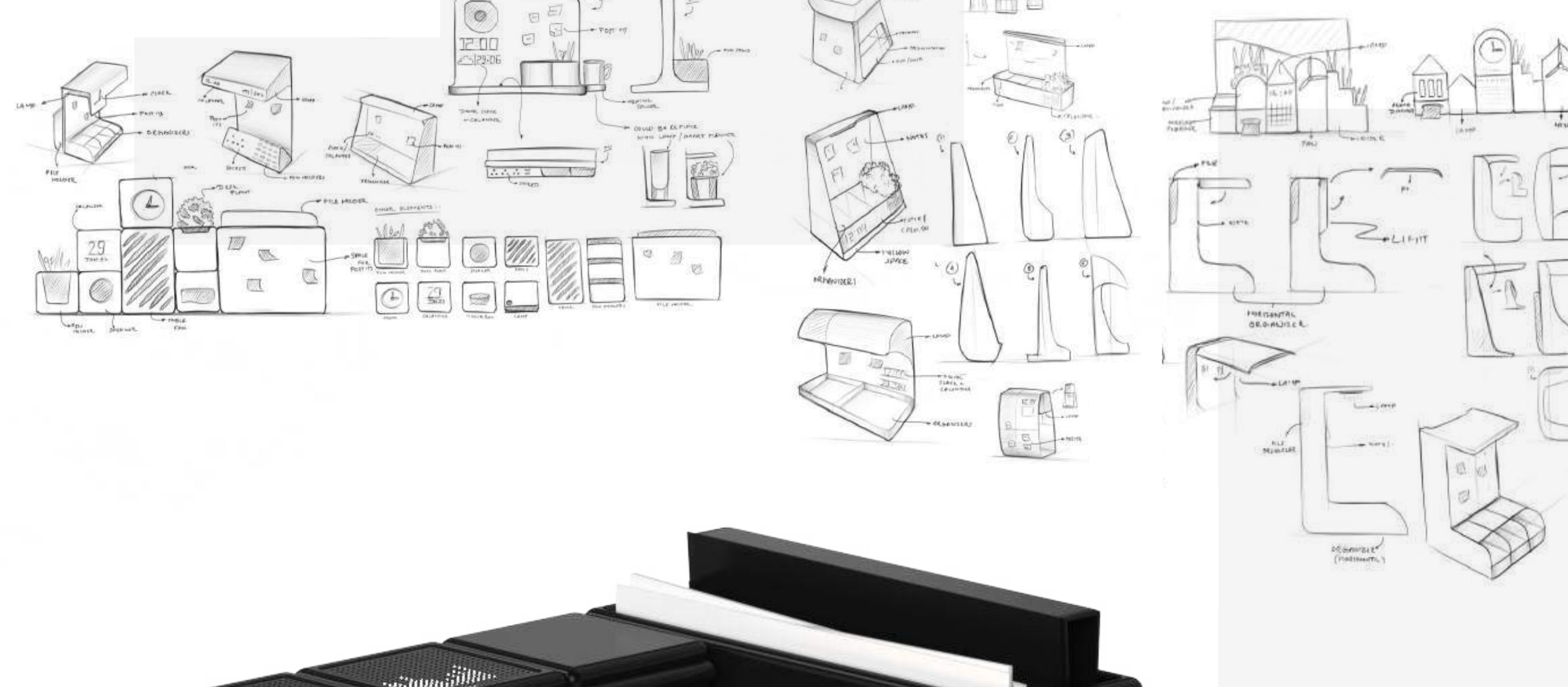



# NIMBUS

Nimbus is a wall mounted refilling system designed by combining product and packaging, aiming to reshape consumer and manufacturer behavior. Their dispenser, widely embraced, utilizes transport packaging as an essential product element. With multiple cartridges, it simplifies travel, eliminating the need for numerous toiletry items. A simple squeeze dispenses the desired product, reducing hassle when using multiple products sequentially.

**Compact**

**Organised**

**Modular**

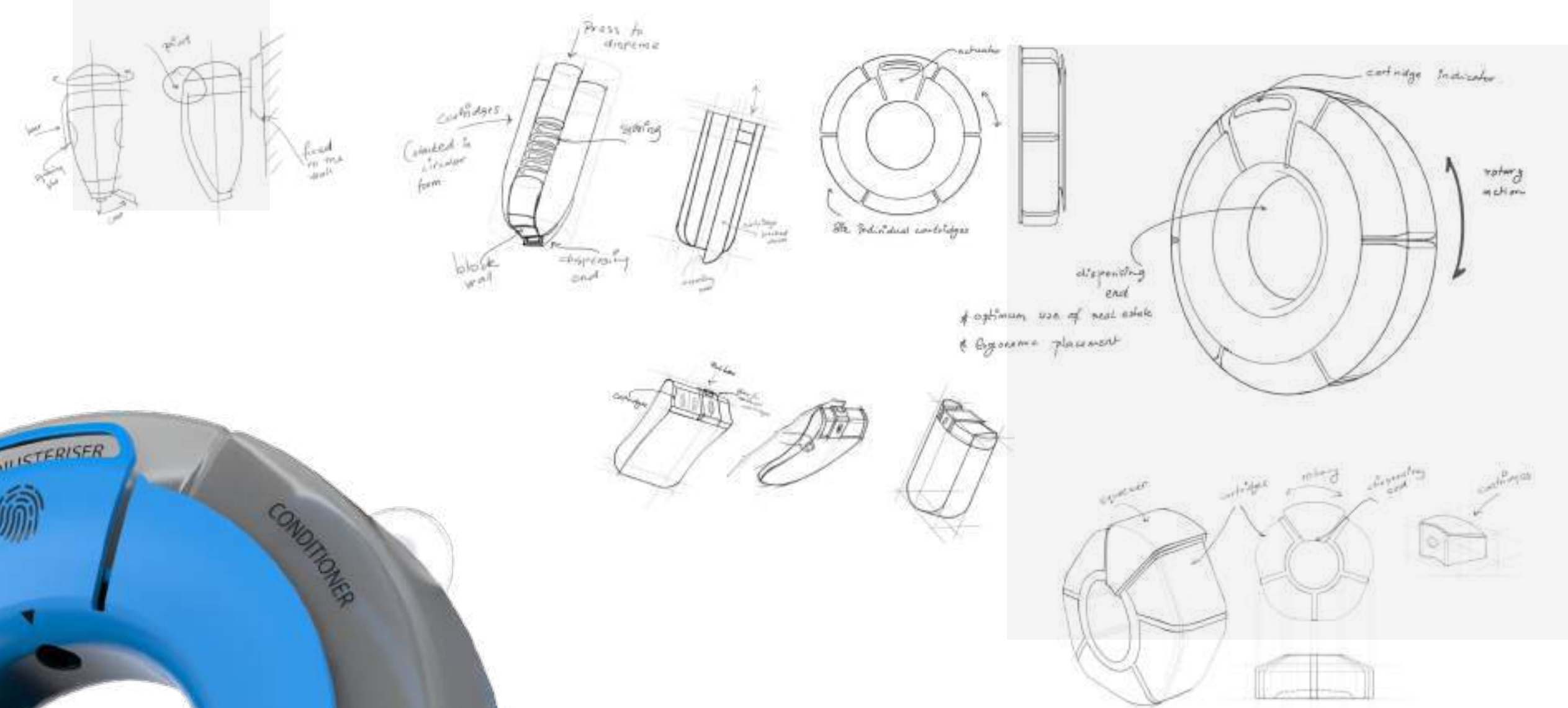



# PRODUCTS & PROTOTYPES





# CLIENTELE



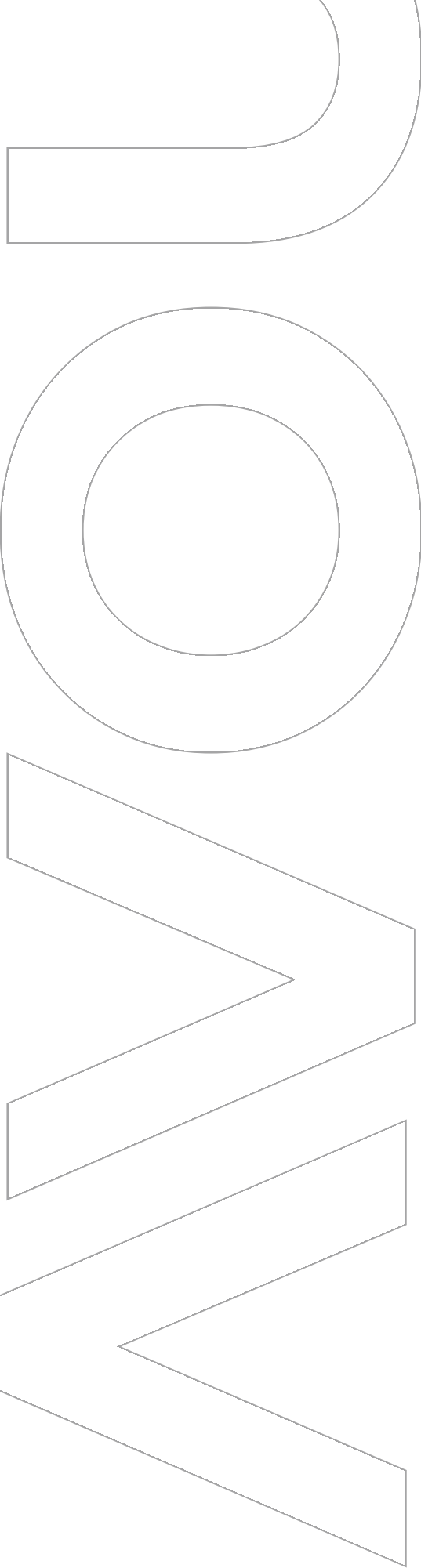

# THANK YOU

## Office Address

Office No - 504, Filix Tower, Lal Bahadur Shastri Rd,  
Bhandup West, Mumbai, Maharashtra 400078.

 <https://iuovadesign.com/>

|  [Info@iuovadesign.com](mailto:Info@iuovadesign.com)

|  +91-8369083208

## FOLLOW US

